



USER MANUAL

DVI Matrix Router – ODM3636

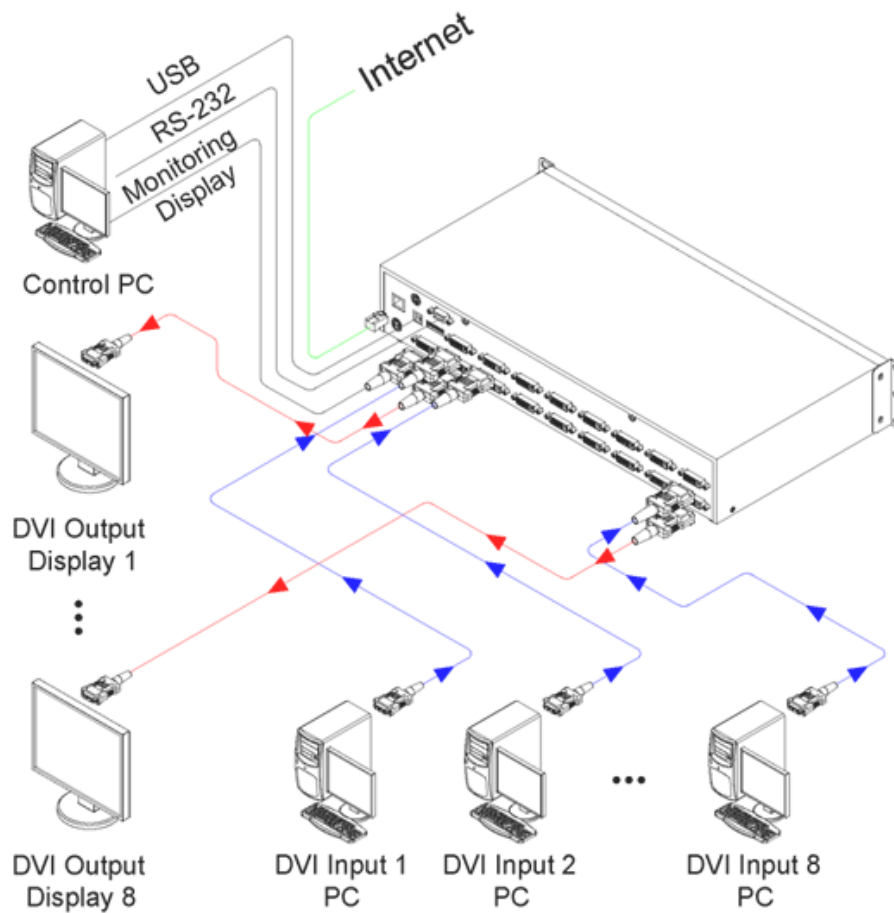



Table of Contents

1	Introduction and Installation	4
1.1	Key features:	4
1.2	ODM3636 Shipping Content:	4
1.3	Safety Instructions	5
1.4	Physical Description	5
1.4.1	Front Panel	5
1.4.2	Rear Panel	6
1.5	EDID Control and Configuration	7
1.6	Connecting Optical DVI cables and modules for extended distance	8
1.7	Initializing ODM3636 and Installation Guide	8
1.7.1	Initialization	8
1.7.2	Rack Mounting	9
1.7.3	Control Connection	9
1.7.4	RS-232 Control	9
1.7.5	Ethernet Control	9
1.7.6	Direct connection of PC or video controller to ODM3636: Use a crossover Ethernet cable	9
1.7.7	LAN connection of ODM3636: Direct Ethernet connection	9
2	Communications Setup	9
2.1	Setting the Router ID of ODM3636	9
2.2	Front Panel Interface	10
2.3	CREATE Mode	10
2.4	PREVIEW Mode	10
2.5	CANCEL Mode	11
2.6	FUNCTION Mode	11
2.6.1	MONITOR OUTPUT SELCTION	11
2.6.2	RS-232 BAUD RATE	11
2.6.3	GATEWAY	12
2.6.4	SUBNET MASK	12
2.6.5	IP ADDRESS	12
2.6.6	MAC ADDRESS	13
2.6.7	PORT NUMBER	13
2.6.8	EDID SAVE	14
2.6.9	FACTORY MODE	14
2.7	Serial Communication	14
2.7.1	HyperTerminal	14
2.7.2	Telnet	16
2.7.3	LAUNCHING TELNET SESSION	16
2.8	Ethernet Control	18
2.8.1	SETTING THE IP ADDRESS of the PC	18
2.9	USB CONTROL	19
3	Operation	19
3.1	Front Panel Operation	19
3.2	Command Line Operation	21
3.2.1	Create:	23
3.2.2	Preview: Shows all Input-Output configurations	25
3.2.3	Cancel: Cancels configuration of outputs for each Input.	25
3.2.4	Upload Data Request: Uploads connection data to the controller.	25
3.2.5	Upload Data Request:	25
3.2.6	Rolling command	26



3.2.7	Upload Router ID.....	27
3.2.8	Rolling Stop.....	28
3.2.9	Check Connection.....	28
3.2.10	Upload One Channel Data Request.....	28
3.2.11	Read Output Device EDID.....	29
3.2.12	Read Input EEPROM EDID.....	29
3.2.13	EDID Write.....	30
3.2.14	Default EDID Setting.....	30
3.2.15	Baud rate Setting.....	31
3.2.16	Monitoring.....	31
3.3	Web Control Panel Operation.....	32
3.4	Proprietary PC Software Operation.....	32
3.4.1	Installation of PC Application.....	32
3.4.2	Installation of USB Driver.....	34
3.4.3	PC Operation using RS-232.....	36
3.4.4	PC Operation using Ethernet.....	36
3.5	Control Buttons.....	38
3.6	File menu.....	39
3.7	Edit Pattern.....	39
3.8	Rolling Function.....	41
3.8.1	Single Rolling.....	42
3.8.2	Unlimited Rolling.....	42
3.9	EDID Setting.....	43
3.9.1	Features:.....	43
3.9.2	Importance of EDID - Example.....	43
3.9.3	Setting EDID.....	43
3.9.4	Write EDID.....	44
3.9.5	Read EDID.....	44
3.9.6	Read EDID from Output Device.....	45
3.9.7	File Save/Open EDID.....	45
3.9.8	EDID EDIT.....	46
4	Troubleshooting.....	47
5	Features.....	48
6	Specification.....	48
7	Firmware downloading.....	49
7.1	Installation of the Ponyprog2000.....	49
7.2	Download of Firmware.....	54

1 Introduction and Installation

ODM3636 is a high speed cross-switch with 36 DVI inputs and 36 DVI outputs housed in a ruggedized metal enclosure to protect against harsh environments.

1.1 Key features:

- Eight (36) DVI single-link inputs and outputs
- Pixel resolution up to WUXGA (1920x1200) @ 60Hz refresh ratio – with 1.65Gbps transmission bandwidth
- Dynamic EDID management – adapts to overall power management of the system
 - Restores the default EDID to Input port
 - Reads EDID from display and stores EDID to Input port via EEPROM
- Long distance extension of DVI Input and Output by Optical DVI cables or modules
- Re-Clocking of R, G, B of DVI inputs and outputs
- Various Control Interfaces:
 - Front panel key input
 - Input commands through RS232, LAN, and USB
 - Graphical user interface using Ethernet and Proprietary PC software in the shipped system
- Hierarchical connection of multiple ODM3636 - up to 3 levels to increase the number of display connections or source connections
- DIP switch for up to 255 different ID settings for multiple use of ODM3636 over RS232 connection
- IP setting for Ethernet – point-to-point and local network control

1.2 ODM3636 Shipping Content:



- ODM3636 Mainframe: 1 EA
- Hard carrying case: 1 EA
- AC/DC power adaptor (12V/10A, AC110V-240V): 1 EA
- AC power cord: 1 EA
- User Manual: 1 EA
- PC control software CD: 1 EA



- A plug – B plug USB cable: 1 EA
- Firmware download cable: 1 EA
- RS-232 cable (crossed type): 1 EA
- RJ-45 UTP cable (crossed type): 1 EA



1.3 Safety Instructions

- Use of the equipment in a manner not specified by the manufacturer may result in irrecoverable damage.
- Use the assigned power cord or power adaptor shipped with the system.
- Connect the power cord to the normal and safe outlet.
- Keep the unit away from liquid, magnetic and combustible substances.
- Do not place heavy weight on the unit.
- Move away from noisy environment such as vibration or impact.
- Do not install the unit vertically.
- Do not disassemble the unit.
- When malfunction or breakdown occurs, contact factory immediately.

1.4 Physical Description

1.4.1 Front Panel

- ODM3636 chassis is mountable on a 19" standard rack with rack ears. Control keys, Input-Output buttons and the status LCD display, are placed on the front panel as shown in Figure 1-1.
- Control keys: ①
 - **CREATE** – Update or Configure Input-Output setup
 - **PREVIEW** – Displays current status of Input-Output configuration
 - **CANCEL** - Resets all Outputs configured with an Input or Reject any key inputs
 - **ENTER** - Accepts keyed inputs and completes configuration of Input-Output setup
 - **FUNCTION** - Configures IP for Ethernet, baud rate for RS232 and EDID
- Input-Output Buttons:
 - Eight (36) LED inputs: ②
 - Eight (36) LED outputs: ③
- Status display: LCD displays the control status in 20x4 text mode: ④
- POWER ON/OFF button: ⑤
- **RESET** button – Restart System ⑥

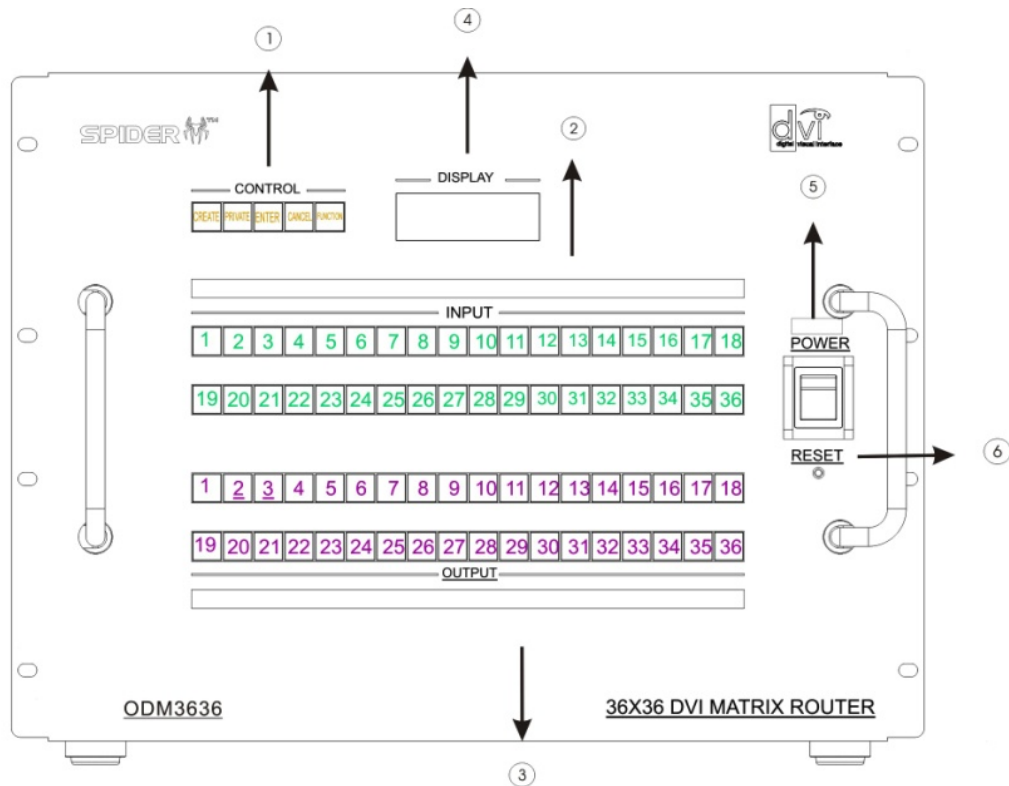

Figure 1-1 Front Panel

1.4.2 Rear Panel

- All Input ports, Output ports, interface ports and power connections are placed on the rear panel as follows;
 - Eight (36) single link DVI inputs: ①
 - Eight (36) single link DVI outputs: ②
 - DIP switch - 8 bits to set ID (identifier) in case of multiple connection of ODM3636: ③
 - USB B type receptacle port: ④
 - RS-232 Serial port: ⑤
 - 10/100 Base Ethernet port: ⑥
 - Firmware download port: ⑦
 - DC power receptacle: ⑧
 - MONITORING DVI port – monitors a designated source for test purpose: ⑨

[Note] For ODM3636, Output #1 will be disconnected automatically when monitoring port is connected and working.

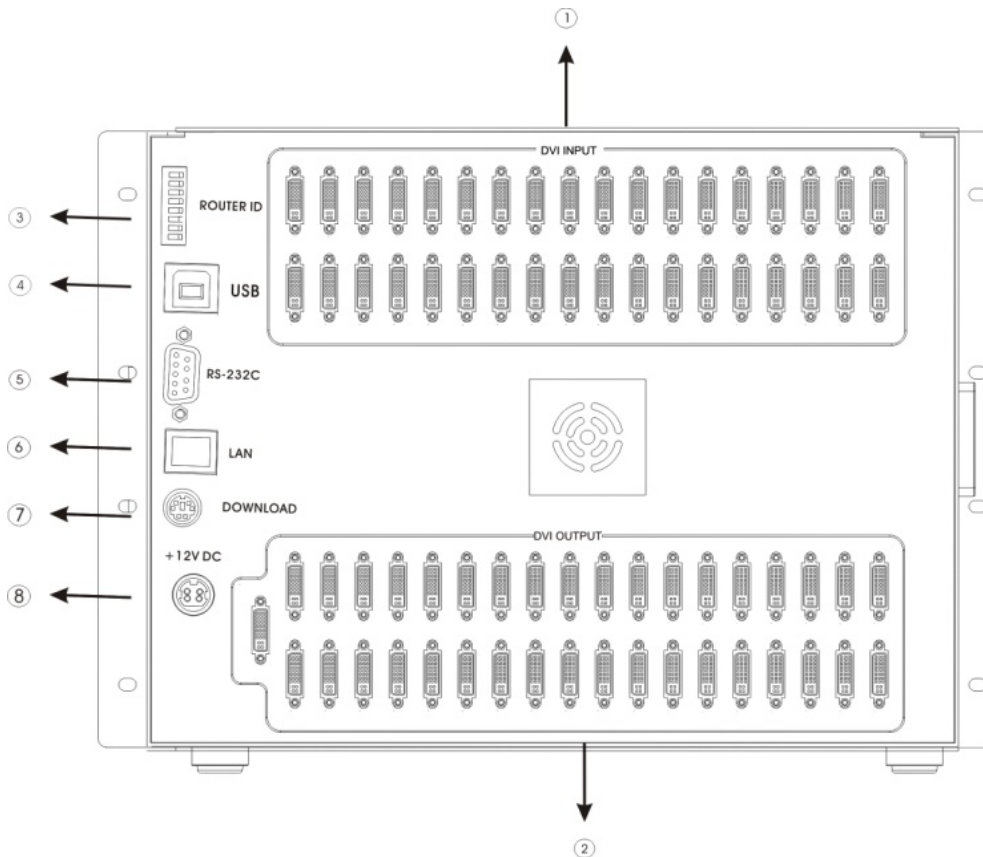

Figure 1-2 Rear Panel

1.5 EDID Control and Configuration

- EDID (Extended Display Identification Data) is an information set that is provided by a display to describe its capabilities to a graphic source. It enables a graphic source to identify the connected display.
- The information set includes: manufacturer, product type, phosphor or filter type, timings supported by the display, display size, luminance data and (for digital displays only) pixel mapping data.
- Once the graphic source reads the information set (usually during the booting process), the EDID determines the optimal format for a connected display.
- ODM3636 supports storing of EDID information to an EEPROM for each Input by dedicated PC software.
- ODM3636 has two-way EDID settings, default EDID from factory and direct readout of stored EDID of any target display. The default EDID setting from the factory is 1080p (1920 x 1080) @ 60Hz for all inputs.

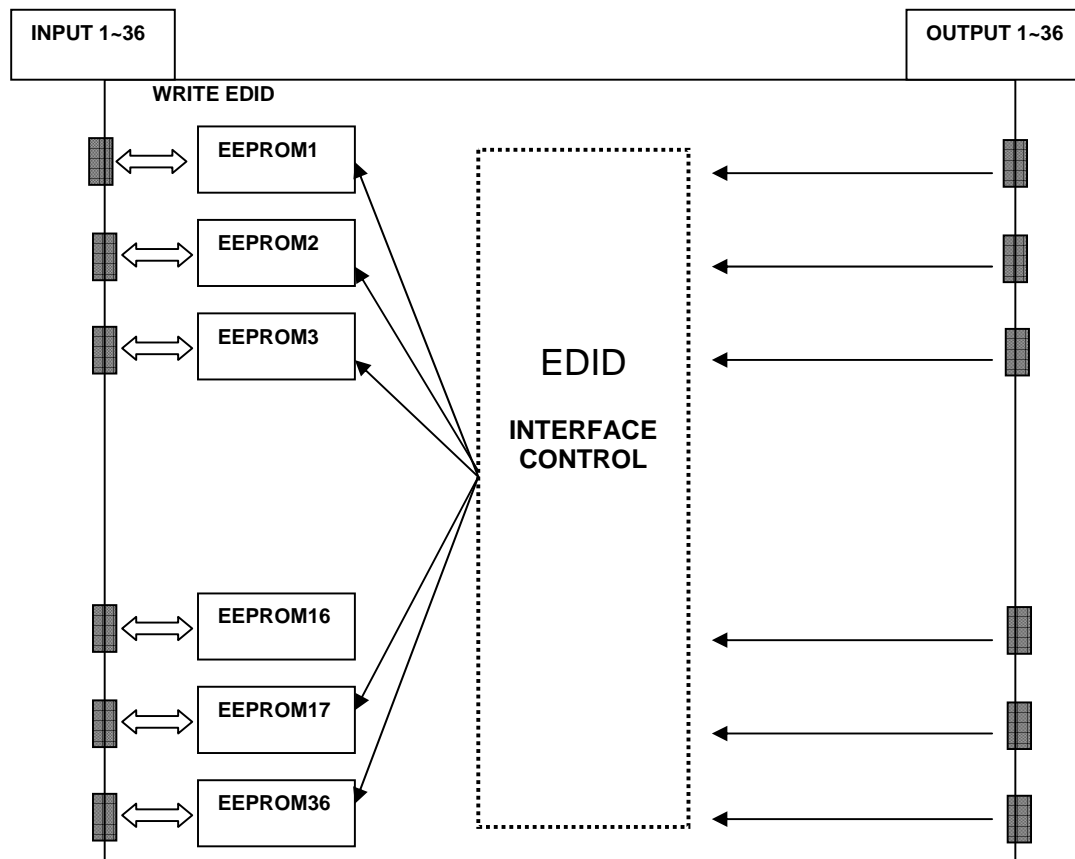

Figure 1-3 Concept drawing for setting EDID in ODM3636

- As depicted in Figure 1-3, once EDID is configured, each EDID is stored in EEPROM at the front of the DVI Input. As a result, the video sources are able to read EDID from the EEPROM during boot-up; even though the ODM3636 and connected displays are not powered on yet.

1.6 Connecting Optical DVI cables and modules for extended distance

- ODM3636 supports connection of Optical DVI cables or modules to all inputs and outputs. The use of copper DVI cables over 3m (10ft.) is not recommended.

1.7 Initializing ODM3636 and Installation Guide

1.7.1 Initialization

- 1) Plug the provided AC power cord to the AC/DC power adaptor then plug the DC cord to the +12VDC connector on the rear panel; make sure that the arrow mark on the connector of the DC cord is aligned.
- 2) Push POWER button on the front panel then observe:
 - All LED (on the button) – will light up



- Display – will display “Initializing ...”
- Display – will show “**36 by 36 DVI Matrix Router**”
- The system is now ready to accept commands.

1.7.2 Rack Mounting

- Before installing cables, attach two rack ears on left and right side of ODM3636 using the supplied screws.

1.7.3 Control Connection

- Commands and functions of ODM3636 are transferred through the RS-232 and Ethernet connection. USB connection is only valid with proprietary Windows PC Software; contained in the CD ROM provided with the system.

1.7.4 RS-232 Control

- Connect the ODM3636 to a video controller or PC with the supplied RS-232 cable.

1.7.5 Ethernet Control

- Connect the ODM3636 to a video controller or PC with the RJ-45 connector/cable.

1.7.6 Direct connection of PC or video controller to the ODM3636: Use a crossover Ethernet cable.

- Typically, a PC is connected to the network and configured for dynamic IP address by a network DHCP server. If the PC is connected directly to the ODM3636, the network server will not be able to address the PC.
- In this case, the PC should be manually set in a static IP address. Refer to Setting the PC IP address in Chp. 2.8.1.

1.7.7 LAN connection of ODM3636: Direct Ethernet connection.

- ODM3636 is configured at the factory with the default IP address of 192.168.0.88. Before connecting to your network, verify the IP address on your network.
- Front key buttons or command lines can reconfigure the IP address over RS 232, Ethernet and USB.

2 Communications Setup

2.1 Setting the Router ID of ODM3636

- If multiple units of ODM3636 with a video controller or PC controller are used, each ODM3636 should be identified with the Dipswitch located on the rear panel marked as Router ID. Each Dipswitch has 8 digits, one (1) at the up position and zero (0) at the down position; possible ranges are 000 to 255 and the default factory setting is 255.

Example Setting

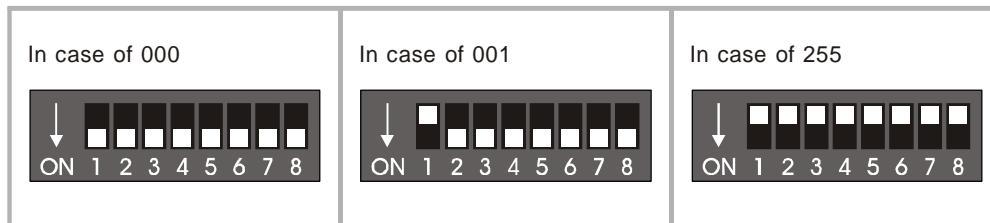

- All command codes are required to have the Router ID in its header. For more details, refer to the command code instruction in Chapter. 3.2.

2.2 Front Panel Interface

- All communication with ODM3636 is possible using the front input keys - without video controller or control PC.
 - Before pressing control keys, make sure that the LCD display shows **USER MODE**.
 - **CREATE, PREVIEW** and **CANCEL** keys are activated and deactivated by pressing each key repeatedly - the activated key is executed by pressing **ENTER** key.
 - **The FUNCTION** has the ability to select multiple features on the ODM3636.
 - Repeatedly pressing the **FUNCTION** key will display each feature on the LCD display.
 - To save the selected feature, press **ENTER** - to escape current setting, press another control key; i.e. **CREATE** or **PREVIEW**.

2.3 CREATE Mode

- Configures Input-Output connections for cross switching.
 - 1) Press CREATE button once to activate (orange color LED is on) - LCD will display the Input channel.
 - 2) Select and Press an input key (the respective Green LED is on) – LCD will display Input channel number.
 - 3) Press single or multiple Output buttons to select desired outputs (Red LED is on for each selected Output button).
 - 4) Outputs can be deselected by pressing the respective Output button (Red LED is off)
 - 5) Press ENTER to save the selected configuration.
 - 6) To configure the next Input to Output or outputs, repeat steps 1 to 5.

2.4 PREVIEW Mode

- PREVIEW mode shows current Input-Output configuration.
 - 1) Press PREVIEW button.
 - 2) Press any Input button (Green LED is on) to see the current connected Output (indicated by Red LED is on)
 - 3) To preview status of another Output, press another Input button.
To see the status of all Input-Output connections, press **PREVIEW** then **ENTER**.



===== RS-232 Baud Rate =====

Entry (1,2,3,4):
Baud Rate: 19200

[Note] Baud Rate of 19200 bps is highly recommended.

2.6.3 GATEWAY: press FUNCTION three times

- The Under Bar mark represents selected and activated.
- Pressing Input '1~9' button changes the number from 1 to 9 and Input 10 button change the number to '0'.
- Input 17 and 18 buttons make the Under Bar move to left and right, respectively.

=====Network Info=====

Gate Way
192. 168. 000. 001
192. 168. 000. 001

- Factory setting is 192.168.000.
- Press **ENTER** button to complete the process and return to the **User mode**.

2.6.4 SUBNET MASK: press FUNCTION four times

- The Under Bar mark represents selected and activated.
- Pressing Input '1~9' button changes the number from 1 to 9 and Input 10 button change the number to '0'.
- Input 17 and 18 buttons make the Under Bar move to left and right, respectively.

===== Network Info =====

Subnet Mask
255. 255. 255. 000
255. 255. 255. 000

- Factory setting is 255. 255. 255.000.
- Press **ENTER** button to complete the process and return to the **User mode**.

2.6.5 IP ADDRESS: press FUNCTION five times

- The Under Bar mark represents selected and activated.
- Pressing Input '1~9' button changes the number from 1 to 9 and Input 10 button change the number to '0'.
- Input 17 and 18 buttons make the Under Bar move to left and right, respectively.



===== Network Info =====

Local IP

192. 168. 000. 088

192. 168. 000. 088

- Factory setting is 192. 168. 000. 088.
- Press **ENTER** button to complete the process and return to the **User mode**.

2.6.6 MAC ADDRESS: press FUNCTION six times

- In computer networking, a Media Access Control address (MAC address) is a unique identifier assigned to most network adapters or network interface cards by the manufacturer for identification, and used in the Media Access Control protocol sub layer. If assigned by the manufacturer, a MAC address usually encodes the manufacturer's registered identification number. It may also be known as an Ethernet Hardware Address (EHA), hardware address, adapter address, or physical address.
 - There are three numbering spaces, managed by the Institute of Electrical and Electronics Engineers (IEEE), which are in common use for formulating a MAC address:
 - ODM3636 is shipped with a default MAC ADDRESS. The MAC ADDRESS of ODM3636 can be edited, however, it is strongly not recommended.
 - Editing MAC ADDRESS
 - The Under Bar mark represents selected and activated.
 - Pressing Input '1~9' button changes the number from 1 to 9 and Input 10 button change the number to '0'.
 - Pressing input '11~16' button changes the Alphabet from 'A to F'.
 - Input 17 and 18 buttons make the Under Bar move to left and right, respectively.

2.6.7 PORT NUMBER: press FUNCTION seven times

- The Under Bar mark represents selected and activated.
- Pressing Input '1~9' button changes the number from 1 to 9 and Input 10 button change the number to '0'.
- Input 17 and 18 buttons make the Under Bar move to left and right, respectively.

=====Network Info=====

UDP port: 3000

- Factory setting is 03000.
- Press **ENTER** button to complete the process and return to the **User mode**.

[Note] Port number setting in this section is for UDP with supplied PC software not TCP/IP with web browser or Telnet. For TCP/IP, port number 23 is fixed value.



2.6.8 EDID SAVE: press FUNCTION eight times

- Reads EDID from connected displays and stores information to Input ports EEPROM.

===== EDID Connection =====

Old:	1.	2.	3.	4.	5.	6.
New:	PR.	PR.	PR.	PR.	3.	PR.

- Row “Old” represents current EDID while “New” represents EDID to be saved.
- Each Column 1 through 36 represents each Input port: i.e. the fifth column ‘3’ represents the EDID information from connected display at Output port 3 was saved in Input port 5 EEPROM.
 - The Under Bar mark represents selected and activated.
 - Pressing output ‘1~36’ button changes the number from 1 to 36.
 - Input 15 and 16 buttons make the page move. (Previous and next).
 - Input 17 and 18 buttons make the Under Bar move to left and right, respectively.

[Note] “P” (Previous) is the factory default EDID setting: typically, VESA standard 1920 x 1080 @ 60Hz. For example, to save the input 1~4 EDID with Output 3 and input 5~8 EDID with Output 5; edit “New” row as follow:

===== EDID Save =====

Old:	P.	P.	P.	P.	P.	P.	P.
New:	3.	3.	3.	3.	5.	5.	5.

- Press **ENTER** button to complete the configuration, store the information and execute the process.

2.6.9 FACTORY MODE: press FUNCTION nine times

- Press **ENTER** to reset and restore factory default settings.

2.7 Serial Communication

2.7.1 HyperTerminal

- ODM3636 provides command line interface through serial port, RS-232.
- Hyper Terminal is effective serial emulation software to communicate with ODM3636 when Microsoft Windows operating system is used to control ODM3636.
- Hyper Terminal connection procedures:
 - 1) Connect the ODM3636 to a PC as described in section RS-232 Control.
 - 2) Select Start > Programs > Accessories > Communications > HyperTerminal

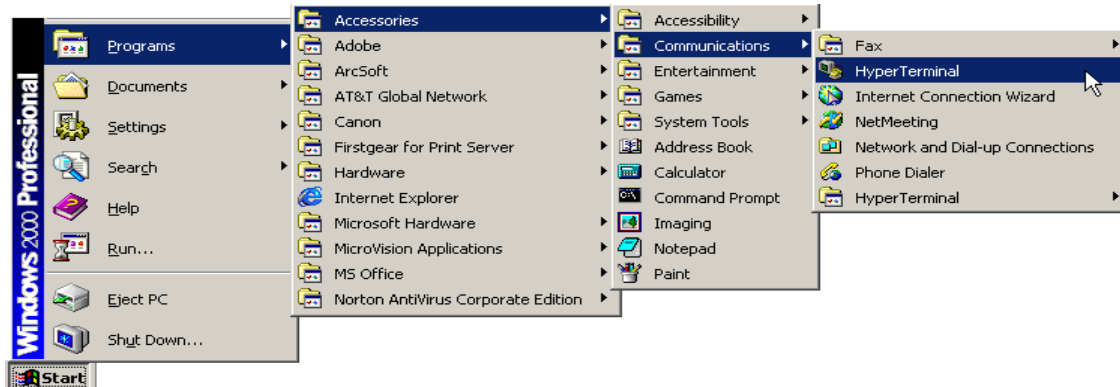

Figure 2-1 HyperTerminal Access

- 3) **Connection Description Dialog:** Enter a name and choose an icon.

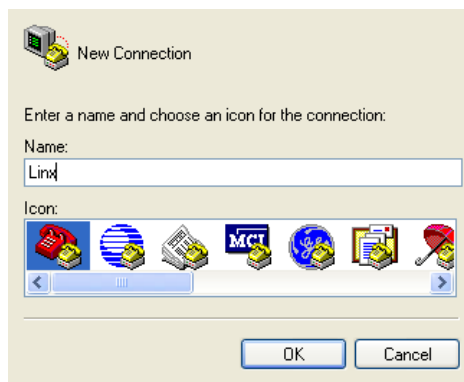

Figure 2-2 Connection Description Dialog

- 4) Selecting **OK** displays the **Connect To** dialog. In the **Connect To** dialog box, ignore the **Country**, **Area Code** and **Phone Number** fields and select the available COM port to which ODM3636 is connected.

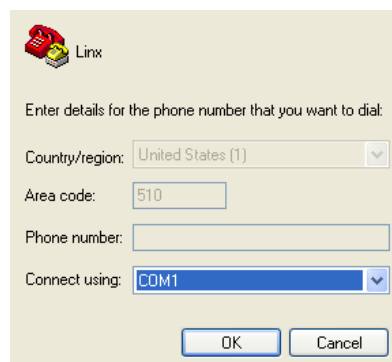

Figure 2-3 Connect To Dialog

- 5) Select **OK** to go to the **COM Properties** dialog box.

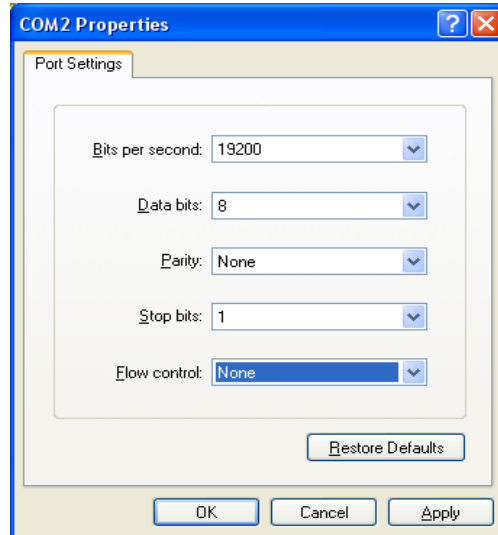

Figure 2-4 COM Properties Dialog

- 6) Configure the port settings as follows;
 - Bits per second (baud rate): 19200 (recommended)
 - Data bits: 8
 - Parity: None
 - Stop bits: 1
 - Flow control: None
- 7) Select **OK** to display the HyperTerminal window
- 8) Press ENTER on ODM3636 to begin communication with ODM3636
- 9) Type serial command set. (Refer to Chap. 3.2)

2.7.2 Telnet

- Telnet is a terminal emulation program for TCP/IP networks such as the Internet.
- The Telnet program runs on your computer and connects your PC to a server on the network. You can then enter commands through the Telnet program and they will be executed as if you were entering them directly on the server console. This enables you to control the server and communicate with other servers on the network

2.7.3 LAUNCHING TELNET SESSION

- 1) Select **Start** menu and select **Run**.
- 2) Type **command** as shown below.

USER MANUAL

DVI MATRIX ROUTER – ODM3636

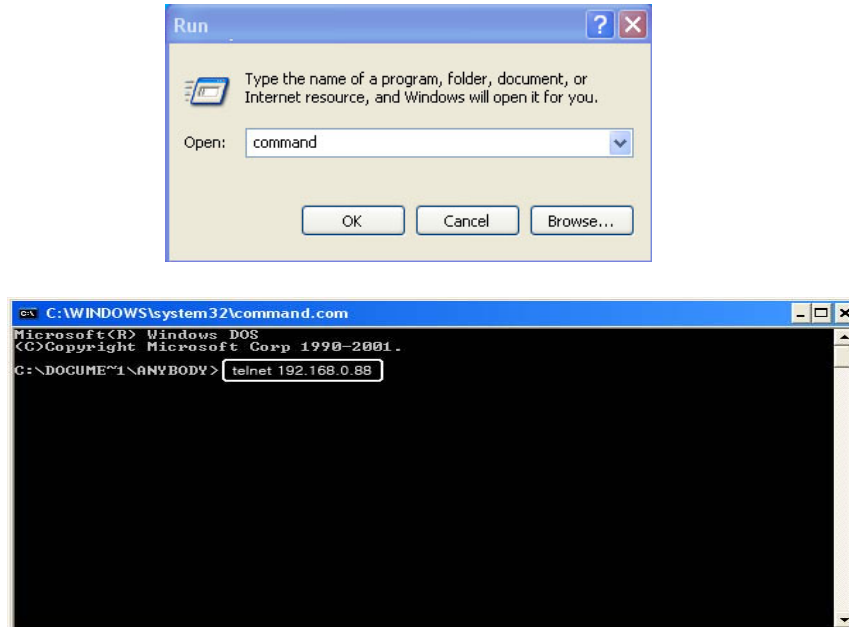

Figure 2-5 Run Windows

- 3) Select **OK** to open the command window.
- 4) Type the command: **telnet 192.168.0.88**

[Note] 192.168.0.88 is the default IP address of ODM3636. Change IP address as needed. (Refer to Chap. 2.6.6 and 2.8)

- 5) Press **ENTER**: “DVI Matrix Router Connected” will be displayed.
- 6) Type serial command set. (Refer to Chap. 3.2)

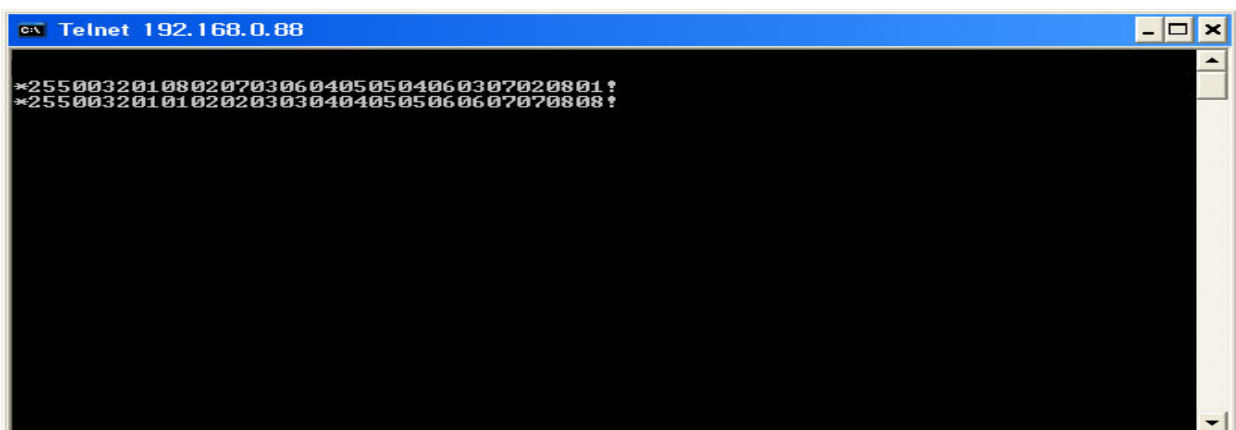

Figure 2-6 Telnet connected

2.8 Ethernet Control

- The ODM3636 can be controlled through the 10/100 base Ethernet port using either graphic user interfaces or a command line interface.
- The graphic user interfaces uses both standard web browser such as Microsoft Internet Explorer and proprietary PC software.
- The physical connection of ODM3636 can be made on the standard LAN or point to point connection.
- The command line interface uses a Telnet session to a private port.
- To connect ODM3636 to Ethernet, specify static IP address for ODM3636 (Refer to Chap. 2.6.5). The default IP address is 192.168.000.088.

2.8.1 SETTING THE IP ADDRESS of the PC

- If the PC is connected to the ODM3636 through the 10/100 Base Ethernet port, a static address should be configured on the PC:
 - 1) Use Ethernet crossover cable (provided with ODM3636 system) for point-to-point direct connection between PC or controller and ODM3636 or use Ethernet strait cable to connect ODM3636 on LAN.
 - 2) From the PC: select **Start** menu, select **Control Panel**.
 - 3) In the **Control Panel**, select **Network Connections**.

In **Network Connections**, right click on **Local Area Connection** and select **Properties** tab.

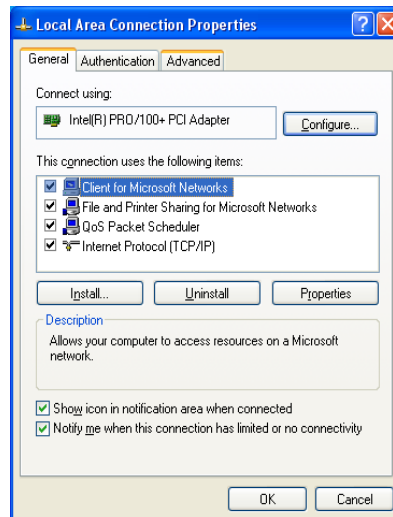

Figure 2-7 Local Area Network Properties

Select **Internet Protocol (TCP/IP)** and click on **Properties**.

In the Internet Protocol (TCP/IP) Properties, click **Use the following IP address** radio button.

Enter IP address compatible with the current IP address of the ODM3636.

- For point to point direct connection, if the IP address of ODM3636 is 192.168.000.088, the PC IP address should be chosen as 192.168.000.nnn; where nnn ranges 000 to 255 except 088. (Refer to Chap. 2.6.5)
- For LAN connection, maintain existing PC IP address then consult you network manager to obtain available IP address for ODM3636.

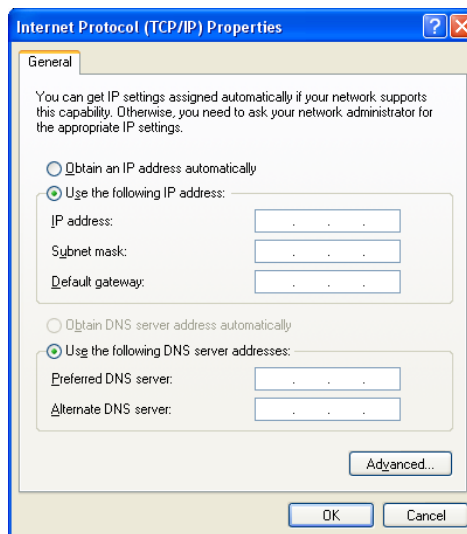

Figure 2-8 PC IP address setting

- 4) Select OK to terminate IP setup session.

2.9 USB CONTROL

- USB connection to ODM3636 is only valid with proprietary PC software – command line interface cannot be used.
- For its device installation and instruction, refer to the Proprietary PC Software Operation in Chap. 3.4.

3 Operation

- ODM3636 has various operational interfaces: Front Panel Key Input, Serial Command Lines, Graphic Interface on web control panel (WCP) and Proprietary PC Software through RS-232, Ethernet or USB.
- Graphic Interface or Proprietary PC Software is the most efficient since all other methods use command line interface.

3.1 Front Panel Operation

- Please Refer to Chap. 2.2 for detail explanation of front keys functions.
- Front Panel Operation examples:
- 36 Displays with 3 different typed of EDID:

USER MANUAL

DVI MATRIX ROUTER – ODM3636

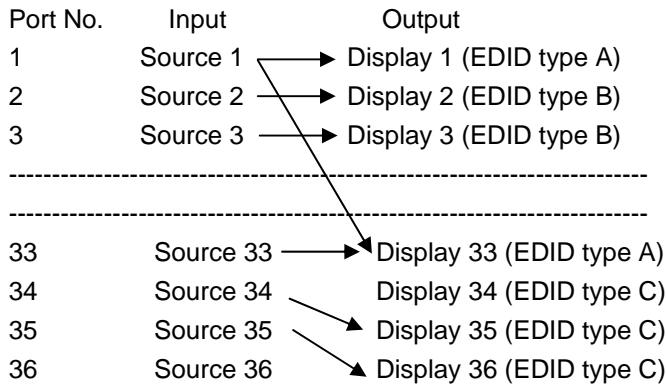

- The arrows represent:
 - Input 1 to Output 1 and 33
 - Input 2 to Output 2
 - Input 3 to Output 3
 - Input 33 to Output 33
 - Input 34 to Output 35
 - Input 35 to Output 36
 - Input 36 no connection
- Operation is executed in two steps:
 - Set EDID for each Input port for proper graphic signal transmittal.
 - Configure Input-Output for cross switching as configured above.

1) Press **FUNCTION** key eight (8) times – LCD will display EDID save:
Configuration like below

```

=====EDID Connection=====
I:    1. 2. 3. 4.
O:    1. 2. 3. P.

=====EDID Connection=====
I:    5. 6. 7. 8.
O:    P. P. P. P.

=====EDID Connection=====
I:    9. 10. 11.12.
O:    P. P. P. P.

=====EDID Connection=====
I:    13. 14.15. 16
O:    P. P. P. P.

=====EDID Connection=====
I:    17. 18. 19. 20.
O:    P. P. P. P.
    
```



=====EDID Connection=====

I: 21.22.23.24.
O: P. P. P. P.

=====EDID Connection=====

I: 25.26.27. 28
O: P. P. P. P.

=====EDID Connection=====

I: 29.30.31.32
O: P. P. P. P.

=====EDID Connection=====

I: 33.34.35.36.
O: 33. 35. 36. P.

[Note 1] If Input has no Output connection (as in Input 36 above), enter P <Previous>.

[Note 2] If a source is connected to two or more different displays, assigning the lower resolution EDID to Input port EEPROM is highly recommended. Assigning higher resolution will show 'OUT OF RANGE'.

2) Press **ENTER** to save.

[Note] EDID setting is valid until a new EDID setting is processed - even though the ODM3636 is powered on and off repeatedly.

3) To configure Input-Output, press **CREATE**; current Input-Output configuration will be displayed.

===== Create Mode =====

Input channel:

4) Press Input button **1** (Green LED is on) – LCD displays:

===== Create Mode =====

Input channel: 1

Press Output 1 and 36 (number **1 and 36**) as the selected outputs for the given Input. Press **ENTER** key and then turn back to the **user mode**.

[Note] Specific Input can be connected to multiple Output channels. However, one Output channel cannot share multiple Input channels.

Repeat above process for other Input channels.

3.2 Command Line Operation

- Command line interface is performed through RS-232 or Ethernet. Refer to Chap. 2.7 and 2.8 for setting procedures.
- The commands are coded in ASCII and HEXA. All descriptions are shown in Table 3.1. A command line consists of string of ASCII or HEXA codes in series as shown below;

Start (1 Byte) + **Router ID** (3 Bytes) + **Command** (1 Byte)
+ **Data Length** (3 Bytes)
+ **Output Number** (2 Bytes) + **Input Number** (2 Bytes)



+ **Output Number** (2 Bytes) + **Input Number** (2 Bytes) +
 + **End** (1 Byte)

- A command line allows execution of only one command. Multiple commands require execution of multiple strings; one command per string.
- All strings begin with **Start** byte.
- **Router ID** can be selected within the range of 000 to 255; written in 3 bytes. (Default factory setting is 255. Refer to Chap. 2.1.)
- **Data Length** represents total number of all bytes. The number of channels in the command line determines data Length.
 - For example: Configuring 4 Input-Output connections (8 channels), data length is 016 in ASCII - 16 bytes in base of 2 bytes per channel regardless of Input and Output.
- **Input channel Number** follows **Output channel Number** - designated as a pair.
- A command line closes with **End** byte.

Table 3.1 Descriptions of Command Codes

Command Format	ASCII	HEX	Description	Byte
Start	*	0x2A	Header Code	1
Router ID	Variable	Variable	Router ID Value	3
Create	0	0x30	Connect or Disconnect the Selected Input and Output channels	1
Preview	1	0x31	Preview all connected channels	
Cancel	2	0x32	Cancel selected channel connection	
Upload Data Request	3	0x33	Upload connection information to the controller	
Rolling	4	0x34	Rotates Input and Output connection	
Upload Router ID	5	0x35	Upload Router ID to controller	
Rolling Stop	6	0x36	Stop rolling command	
Check Connection	7	0x37	Upload connection integrity	
Upload One Channel Data Request	8	0x38	Upload connection status of selected channel	
Baud Rate Setting	@	0x40	Change Baud rate of RS-232	
Read Output Device EDID	A	0x41	Read EDID from attached display	
Default EDID Setting	B	0x42	Restore factory default EDID on EEPROM	
Read Input EEPROM	C	0x43	Read EDID from EEPROM	
EDID Write	D	0x44	Read EDID from display and write to EEPROM	
Edit EDID Write	E	0x45	Edit EDID Write mode	
EDID Data	F	0x46	Send divided data by two	
Monitoring	G	0x47	Set the monitoring channel	
Data Length		Variable		3



Output channel		Variable	Selected Output channel	2
Input channel		Variable	Selected Input channel	2
End	!	0x21	Tail Code	1

- In response to the command line Input to ODM3636, the following ACK signals are returned to the controller shown in Table 3.2.

Table 3.2 Descriptions of Acknowledge (ACK) Signals

Acronym	Bytes	ASCII Codes	Description
Error	1	0x05	Router received incorrect data packet
RX Complete	1	0x06	Router received correct data packet
Job Complete	1	0x07	Completed operation per command
Connection OK	1	0xA0	Successful connection

- ACK will be returned after command codes are sent.
- If the command codes are successfully done, 0x06, 0x07 will be returned. But if it is failed, 0x05 will follow it by return. Some command codes have special ACK and it is described under the each example command code below.

The followings illustrate example codes for various applications to be utilized on HyperTerminal for RS-232 and on Telnet for TCP/IP.

3.2.1 Create:

- Configure cross-switching of inputs and outputs.
- Command line format:
 - *Start (*) + Router ID (3 byte) + Command (0) + Data Length (Variable) + Output channel (2 byte) + Input channel (2 byte) + ... + End (!)*

Example 1: One (1) channel connection of Output Channel 1 and Input Channel 1

	Start	Router ID			Command	Data Length			Output Channel		Input Channel		End
ASCII	*	2	5	5	0	0	0	4	0	1	0	1	!
HEX	2Ah	32h	35h	35h	30h	30h	30h	34h	30h	31h	30h	31h	21h

Example 2: One (1) channel disconnection of Output Channel 1 by setting “0” on the Input channel bytes.

	Start	Router ID			Command	Data Length			Output Channel		Input Channel		End
ASCII	*	2	5	5	0	0	0	4	0	1	0	0	!
HEX	2Ah	32h	35h	35h	30h	30h	30h	34h	30h	31h	30h	30h	21h

USER MANUAL

DVI MATRIX ROUTER – ODM3636



Example 3: Two (2) -channel connections: Output Channel 1 → Input Channel 8 & Output Channel 8 → Input Channel 1

	Start	Router ID			Command	Data Length			Output Channel		Input Channel	
ASCII	*	2	5	5	0	0	0	8	0	1	0	8
HEX	2Ah	32h	35h	35h	30h	30h	30h	38h	30h	31h	30h	38h

Output Channel	Input Channel	End
0	8	!
30h	38h	21h

Example 4: Eight (36) channels direct - through connection

	Start	Router ID			Command	Data Length			Output Channel		Input Channel	
ASCII	*	2	5	5	0	1	4	4	0	1	0	1
HEX	2Ah	32h	35h	35h	30h	31h	34h	34h	30h	31h	30h	31h

Output Channel		Input Channel		...	Output Channel		Input Channel		Output Channel		Input Channel		END
0	2	0	2	...	3	5	3	5	3	6	3	6	!
30h	32h	30h	32h	...	33h	35h	33h	35h	33h	36h	33h	36h	21h



3.2.2 Preview: Shows all Input-Output configurations

- Command line format:
 - Start (*) + Router ID (3 byte) + Command (1) + Data Length (000) + End (!)

Byte	Start	Router ID			Command	Data Length			End
ASCII	*	2	5	5	1	0	0	0	!
Hex	2Ah	32h	35h	35h	31h	30h	30h	30h	21h

3.2.3 Cancel: Cancels configuration of outputs for each Input.

- Command line format:
 - Start (*) + Router ID (3 byte) + Command (2) + Data Length (variable) + Input Channel (2 byte) + End (!)

Example: Disconnect Input Channel 1

Byte	Start	Router ID			Command	Data Length			Input Channel		End
ASCII	*	2	5	5	2	0	0	2	0	1	!
Hex	2Ah	32h	35h	35h	32h	30h	30h	32h	30h	31h	21h

3.2.4 Upload Data Request: Uploads connection data to the controller.

- Command line format:
 - Start (*) + Router ID (3 byte) + Command (3) + Data Length (000) + End (!)

Byte	Start	Router ID			Command	Data Length			End
ASCII	*	2	5	5	3	0	0	0	!
Hex	2Ah	32h	35h	35h	33h	30h	30h	30h	21h

3.2.5 Upload Data Request:

- Allows ODM3636 to respond with ACK signal to controller in the following format: 0x06(06h) + Connection DATA + 0x07(07h)
- The Connection Data represents the connection information of router

Byte	Start	Router ID			Command	Data Length			Output Ch		Input Ch	
ASCII	*	0	0	0	3	1	4	4	0	1	0	1
Hex	2Ah	30h	30h	30h	33h	31h	34h	34h	30h	31h	30h	31h

Output Ch	Input Ch	...	Output Ch	Input Ch	Output Ch	Input Ch	Output Ch	Input Ch	END				
0	2	0	2	3	5	3	5	3	6	3	6	!
30h	32h	30h	32h	33h	35h	33h	35h	33h	36h	33h	36h	21h



3.2.6 Rolling command

- Rotates Input at fixed Output.
- Checks connection status of all inputs and outputs by changing them in sequence.
- Format of Command Line:
 - *Start (*) + Router ID (3 byte) + Command (4) + Data Length (Variable) + Output Channel (2 byte) + Input Channel (2 byte) + ... + End (!)*
 - Ex) To rotate three (3) inputs 1, 2, and 3 on three (3) outputs 1, 2, and 3.

1) Output Channel 1 → Input Channel 1, Output Channel 2 → Input Channel 2, Output Channel 3 → Input Channel 3

Byte	Start	Router ID			Command	Data Length			Output Channel		Input Channel	
ASCII	*	2	5	5	4	0	1	2	0	1	0	1
Hex	2Ah	32h	35h	35h	34h	30h	31h	32h	30h	31h	30h	31h

Output Channel		Input Channel		Output Channel		Input Channel		End
0	2	0	2	0	3	0	3	!
30h	32h	30h	32h	30h	33h	30h	33h	21h

2) Output Channel 1 → Input Channel 2, Output Channel 2 → Input Channel 3, Output Channel 3 → Input Channel 1

Byte	Start	Router ID			Command	Data Length			Output Channel		Input Channel	
ASCII	*	2	5	5	4	0	1	2	0	1	0	2
Hex	2Ah	32h	35h	35h	34h	30h	31h	32h	30h	31h	30h	32h

Output Channel		Input Channel		Output Channel		Input Channel		End
0	2	0	3	0	3	0	1	!
30h	32h	30h	33h	30h	33h	30h	31h	21h

3) Output Channel 1 → Input Channel 3, Output Channel 2 → Input Channel 1, Output Channel 3 → Input Channel 2

Byte	Start	Router ID			Command	Data Length			Output Channel		Input Channel	
ASCII	*	2	5	5	4	0	1	2	0	1	0	3
Hex	2Ah	32h	35h	35h	34h	30h	31h	32h	30h	31h	30h	33h

Output channel		Input channel		Output channel		Input channel		End
0	2	0	1	0	3	0	2	!
30h	32h	30h	31h	30h	33h	30h	32h	21h



3.2.7 Upload Router ID

- Uploads Router ID to the controller or PC.
- Command line format:
 - Start (*) + Router ID (3 byte) + Command (5) + Data Length (000) + End (!)

Byte	Start	Router ID			Command	Data Length			End
ASCII	*	2	5	5	5	0	0	0	!
Hex	2Ah	32h	35h	35h	35h	30h	30h	30h	21h

- If the Router ID is 015, ACK signal is as follows:

Byte	Start	Router ID			Command	End
ASCII	*	0	1	5	5	!
Hex	2Ah	30h	31h	35h	35h	21h



3.2.8 Rolling Stop

- Rolling stop command.
- Command line format:
 - Start (*) + Router ID (3 byte) + Command (6) + Data Length (000) + End (!)

Byte	Start	Router ID			Command	Data Length			End
ASCII	*	2	5	5	6	0	0	0	!
Hex	2Ah	32h	35h	35h	36h	30h	30h	30h	21h

3.2.9 Check Connection

- Check status of all connections
- Command line format:
 - Start (*) + Router ID (3 byte) + Command (7) + Data Length (000) + End (!)

Byte	Start	Router ID			Command	Data Length			End
ASCII	*	2	5	5	7	0	0	0	!
Hex	2Ah	32h	35h	35h	37h	30h	30h	30h	21h

- By sending **Check Connection** command to the router, ODM3636 responds with the following **ACK** signal to controller:
 - Good connection: **0xA0 (A0h)**
 - Bad connection: **0x05 (05h)**

3.2.10 Upload One Channel Data Request

- Upload connection status of a selected Output channel.
- Command line format:
 - Start (*) + Router ID (3 byte) + Command (8) + Data Length (002) + Output channel (2 byte) + End (!)

Input 6 → Output 1 connection

Byte	Start	Router ID			Command	Data Length			Output channel		End
ASCII	*	2	5	5	8	0	0	2	0	1	!
Hex	2Ah	32h	35h	35h	38h	30h	30h	32h	30h	31h	21h

ACK signal

Byte	Start	Router ID			Command	Data Length			Input channel		End
ASCII	*	2	5	5	8	0	0	2	0	6	!
Hex	2Ah	32h	35h	35h	38h	30h	30h	32h	30h	36h	21h



3.2.11 Read Output Device EDID

- Read EDID from connected display.
- Command line format:
 - *Start (*) + Router ID (3 byte) + Command (A) + Data Length (002) + Output channel (2 byte) + End (!)*

Example: Read EDID from a Display connected to Output 1

Byte	Start	Router ID			Command	Data Length			Output Channel		End
ASCII	*	2	5	5	A	0	0	2	0	1	!
Hex	2Ah	32h	35h	35h	41h	30h	30h	32h	30h	31h	21h

ACK signal

Byte	Start	ID			Command	Data Length			Output Channel		EDID (256Byte)	End
ASCII	*	2	5	5	A	2	5	8	0	1	...	!
Hex	2Ah	32h	35h	35h	41h	32h	35h	38h	30h	31h	00h...xxh	21h

EDID (256 Bytes) contains EDID information of Output display 1.

3.2.12 Read Input EEPROM EDID

- Read EDID stored on EEPROM of an Input.
- Format of Command Line:
 - *Start (*) + Router ID (3 byte) + Command (C) + Data Length (002) + Input EEPROM (2 byte) + End (!)*

Example: Read EDID stored on EEPROM of Input 2

Byte	Start	Router ID			Command	Data Length			Input EEPROM		End
ASCII	*	2	5	5	C	0	0	2	0	2	!
Hex	2Ah	32h	35h	35h	43h	30h	30h	32h	30h	32h	21h

ACK signal

Byte	Start	Router ID			Command	Data Length			Input EEPROM		EDID (256Byte)	End
ASCII	*	2	5	5	C	2	5	8	0	2	...	!
Hex	2Ah	32h	35h	35h	43h	32h	35h	38h	30h	32h	00h...xxh	21h

EDID (256 Bytes) contains EDID information stored on EEPROM 2.



3.2.13 EDID Write

- Read EDID information from connected displays and writes EDID to each EEPROM.
- Format of Command Line:
 - *Start (*) + Router ID (3 byte) + Command (D) + Data Length (Variable) + EEPROM 1 (2 byte) + EEPROM 2 (2 byte) + ... + End (!)*
 - Variable in Data Length is determined by multiplying 2 bytes to the maximum number of Input channels. With ODM3636, it is 72 bytes, multiplying 2 bytes by 36 inputs.
 - The 2 bytes in EEPROM # represents the Output port number of target display. For example, 03 in EEPROM 2 represent: load the EDID of Output 3 display into EEPROM 2. The value, 00 in EEPROM # represent: no updating to EEPROM.

Example: Sets, Output 1 display → Input 1 EEPROM; Output 3 display → Input 2 EEPROM)

Byte	Start	Router ID			Command	Data Length			EEPROM 1		EEPROM 2	
ASCII	*	2	5	5	D	0	1	6	0	1	0	3
Hex	2Ah	32h	35h	35h	44h	30h	31h	36h	30h	31h	30h	33h

EEPROM 3			EEPROM 36		END
0	0	0	0	!
30h	30h	30h	30h	21h

3.2.14 Default EDID Setting

- Restores factory default EDID on EEPROM.
- Command line format:
 - *Start (*) + Router ID (3 byte) + Command (B) + Data Length (000) + End (!)*

Byte	Start	Router ID			Command	Data Length			End
ASCII	*	2	5	5	B	0	0	0	!
Hex	2Ah	32h	35h	35h	42h	30h	30h	30h	21h



3.2.15 Baud rate Setting

- Change baud rate through RS-232.
- Command line format:
 - *Start (*) + Router ID (3 byte) + Command (@) + Data Length (002) + Baud Rate (variable) + End (!)*
 - The default baud rate is 19,200
 - Baud rate options:
 - 01 for 19,200bps
 - 02 for 38,400bps
 - 03 for 57,600bps
 - 04 for 115,200bps

Example: Set the baud rate to 38,400bps.

Byte	Start	ID			Command	Data Length			Baud Rate		End
ASCII	*	2	5	5	@	0	0	2	0	2	!
Hex	2Ah	32h	35h	35h	40h	30h	30h	32h	30h	32h	21h

ACK is identical to command code for BAUD RATE SETTING

Byte	Start	ID			Command	Data Length			Baud Rate		End
ASCII	*	2	5	5	@	0	0	2	0	2	!
Hex	2Ah	32h	35h	35h	40h	30h	30h	32h	30h	32h	21h

3.2.16 Monitoring

- Sets monitoring channel.
- Format of Command Line:
 - *Start (*) + Router ID (3 byte) + Command (G) + Data Length (002) + Monitoring Data (2 byte) + End (!)*

Ex.> Set Input Channel 2 as the Monitoring channel

Byte	Start	ID			Command	Data Length			Monitoring Data		End
ASCII	*	2	5	5	G	0	0	2	0	2	!
Hex	2Ah	32h	35h	35h	47h	30h	30h	32h	30h	32h	21h

3.3 Web Control Panel Operation

- The web control panel (WCP) provides a graphic alternative to command line interface.
- The ODM3636 supports standard web browser. Microsoft Explorer is highly recommended.
- Before running the web browser, confirm that Ethernet connection is setup properly (Refer to Chap. 2.8)
- Run the web browser then enter IP address into the URL address line.
- For example, if the IP address of ODM3636 is 192.168.000.088, type the following entry into the URL address line: **http://192.168.000.088**

3.4 Proprietary PC Software Operation

3.4.1 Installation of PC Application

- 1) Insert ODM3636 software CD ROM into PC. If the CD ROM does not automatically run, Select Start >Run. Enter X:\ 'ODM3636-install.exe, (where X is the letter of your CD ROM drive)
- 2) Installation of ODM3636 screen will be opened – select **NEXT**.

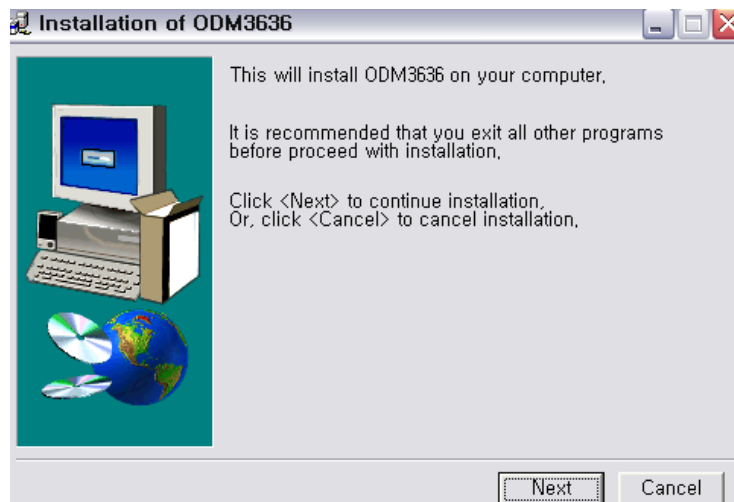

- 3) Select the destination directory path then select **Install**.



- 4) To complete the installation, select the **OK**.

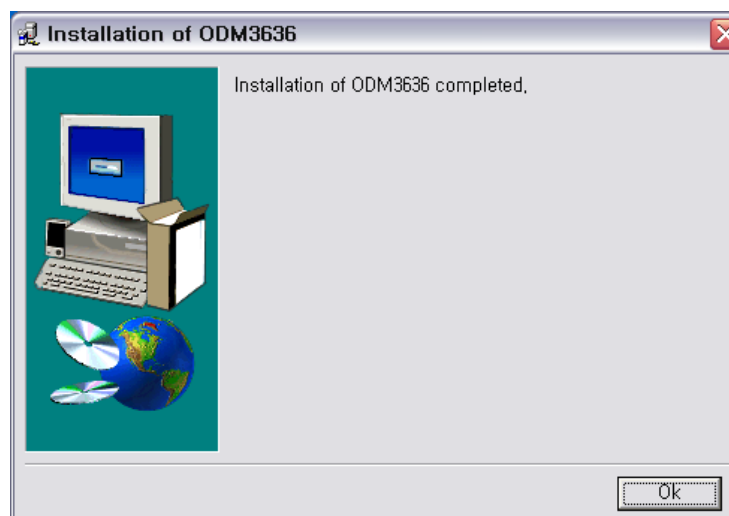

- 5) Select **Yes** to update the registry.
- 6) Select the **OK** button.

3.4.2 Installation of USB Driver

- Windows XP
 - 1) Connect ODM3636 to PC using USB cable then turn on ODM3636.
 - 2) Select “**Install from a list or specific location (Advanced)**” then select ‘**NEXT**’.



- 3) Insert CD ROM then select **Search for the best driver in these locations** and **Include this location in the search** (CD ROM Drive\USB Drive\WinXP NT) then select **NEXT**



- 4) Select the **Continue Anyway** to proceed.



5) Select **FINISH** to complete installation.



3.4.3 PC Operation using RS-232

- 1) Run PC Application.
- 2) Check the communication cable (RS-232, LAN or USB) and turn on the router.
- 3) Double click the PC Application.
- 4) Set identical Router ID number on the PC Application and ODM3636 using the Dipswitch settings on the rear panel of router. (Default factory setting is 255)
- 5) Router will initialize and verify the connection status of communication cable.
- 6) Message 'connection is completed successfully' appears on status display area, and begins loading of switching-patterns from router.
- 7) If incorrect cable, COM port or Router ID is detected, message 'Device Not Found' will appear on the status display.
- 8) Verify that cable is securely connected then check COM port.
 - To check COM port, click right side of 'RS-232' button and make sure the COM port number and baud rate are set properly. Make necessary changes then click left side of RS-232 to initiate RS-232 connection again.

[Note] The default interface for PC Application is RS-232. See below instructions to use LAN.

3.4.4 PC Operation using Ethernet

- Network configuration by PC program.
 - 1) Select right side of **Ethernet** button to configure the network setup as below:

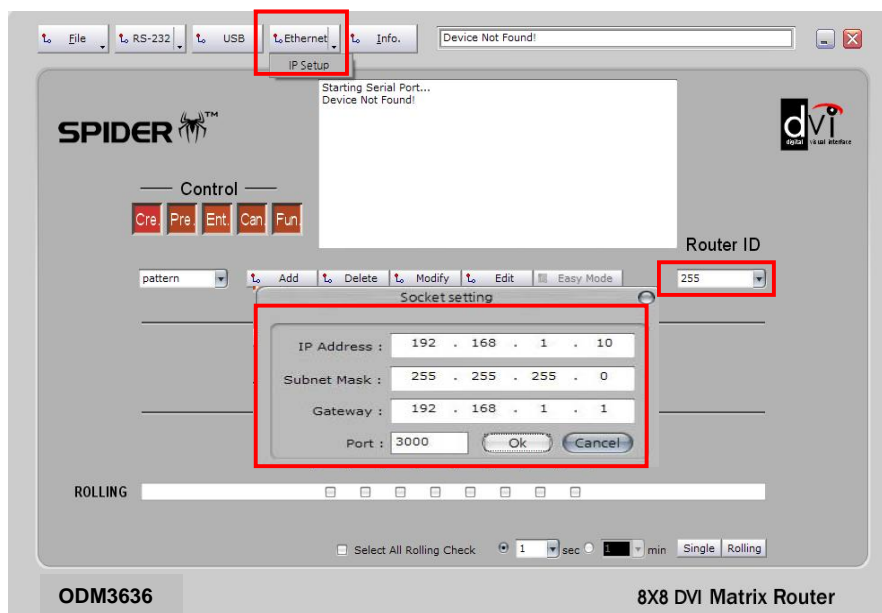

- 2) Enter identical IP address as the Router. (Refer to Chap. 2.6.5)

- 3) Users can now create or update the switching-patterns.
- 4) Message box will display Overwrite (Y) or Insert (N).
 - Select **Y**: Overwrite the old switching-data
 - Select **N**: Create new switching-pattern

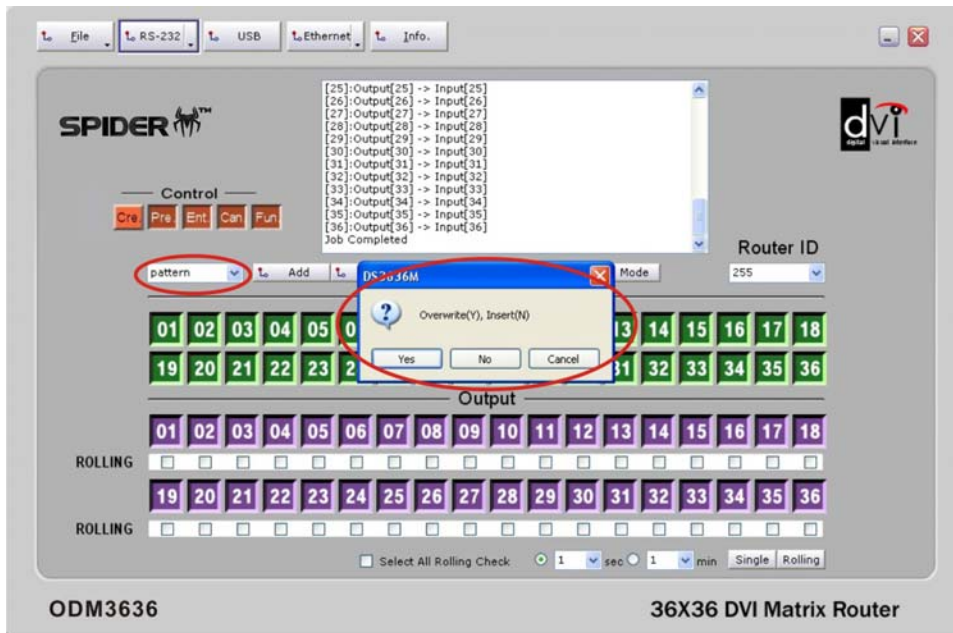

- 5) Enter new pattern name then select **Accept**.



- 6) Once the system has updated and created the switching-patterns, **Job Completed** message will be displayed.

3.5 Control Buttons

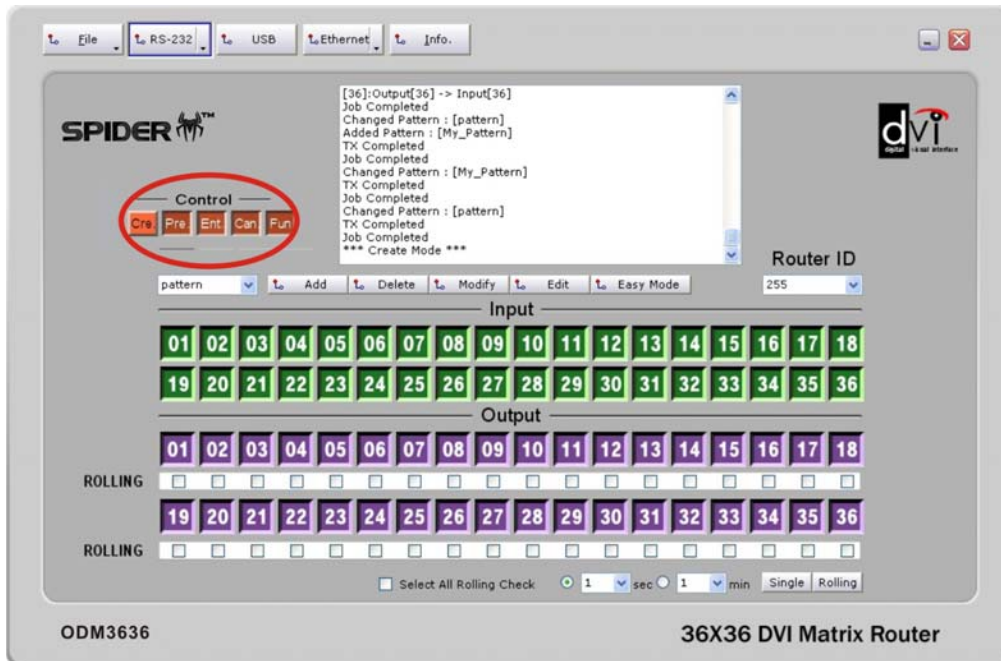

- **Cre** (Create)
 - Configures Input-Output channel connections; same function as the Create-Button on front panel of ODM3636.
 - Process flow: **Cre** Button → **Input** Button → **Output** Button → **Ent** Button
- **Pre** (Preview)
 - Verifies current Input-Output connection status; same function as the Preview-Button on front panel of ODM3636.
 - Process:
 - **Pre** Button → **Input** Button (Single Mode),
 - **Pre** Button → **Ent** Button (Auto Mode)
- **Can** (Cancel)
 - Disconnects Input and Output; same function as the Cancel-Button on front panel of ODM3636.
 - Process: **Can** Button → **Input** Button → **Ent** Button

3.6 File menu

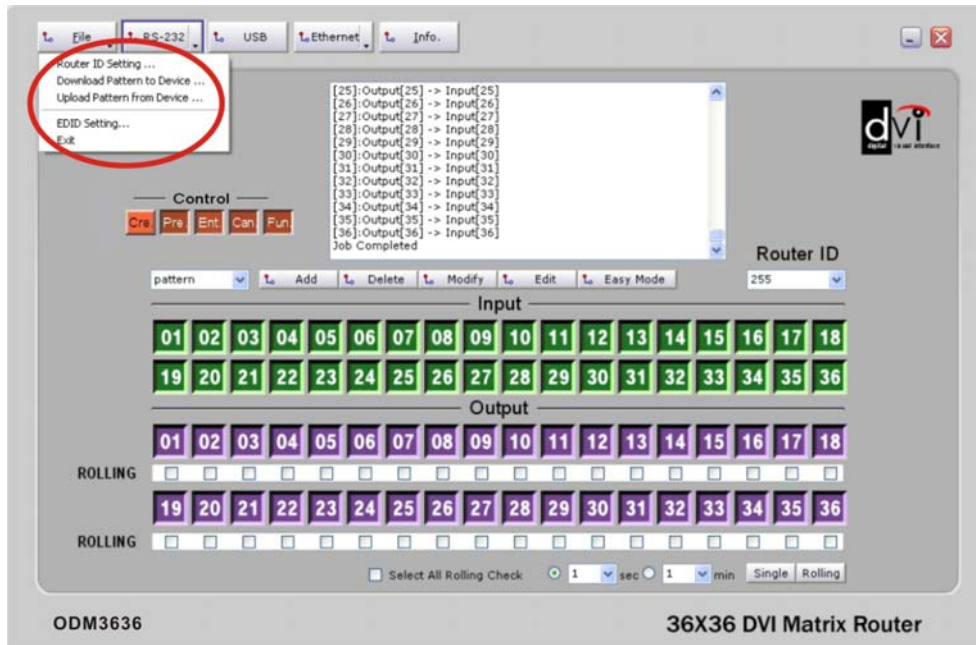

- **Router ID Setting**
 - Provides temporary control of the router by removing router ID number; used when router ID is lost or forgotten and the Dipswitch is not easily accessible.
- **Download Patten to Device**
 - Downloads current Input-Output channel patterns from PC Application to the router.
- **Upload Pattern from Device**
 - Uploads current Input-Output channel patterns from router to the PC Application.
- **Exit**
 - Terminates the program on ODM3636.

3.7 Edit Pattern

- **Edit:** Modifies the current Input-Output switching pattern.
 - 1) Select **Edit** button.
 - 2) Current Input and Output names and switching pattern will be shown.
 - 3) Assign new Input and Output names and switching pattern.
 - 4) Select **Save** to store changes.

USER MANUAL

DVI MATRIX ROUTER – ODM3636



- Scrolling the mouse over the Input numbers will display current connection.
- Users can check the switching-pattern database in the program folder (c:\program files\ ODM3636).

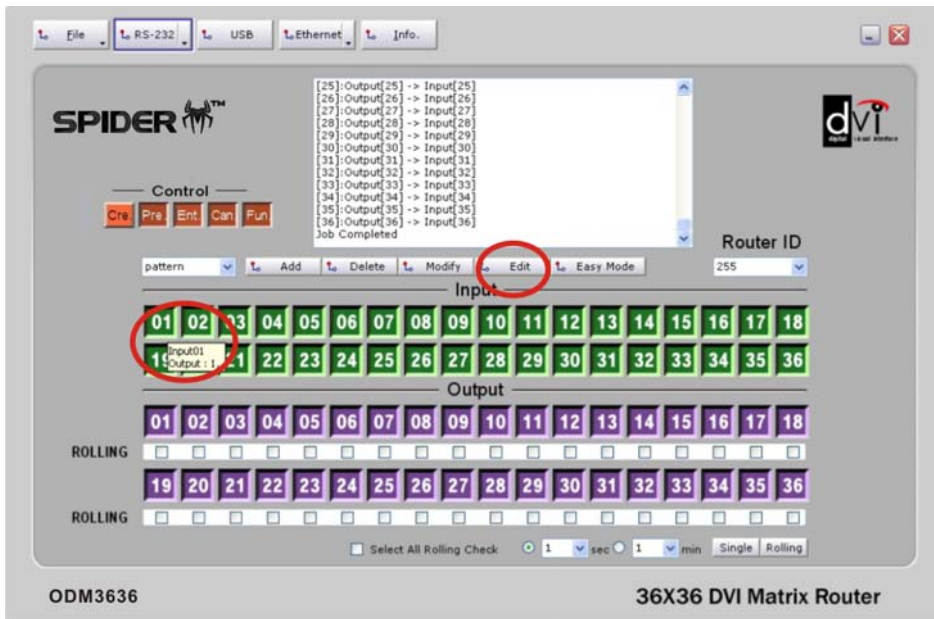

- **Add**
 - 1) Set the pattern name as (My_Grace) then select **Add**.

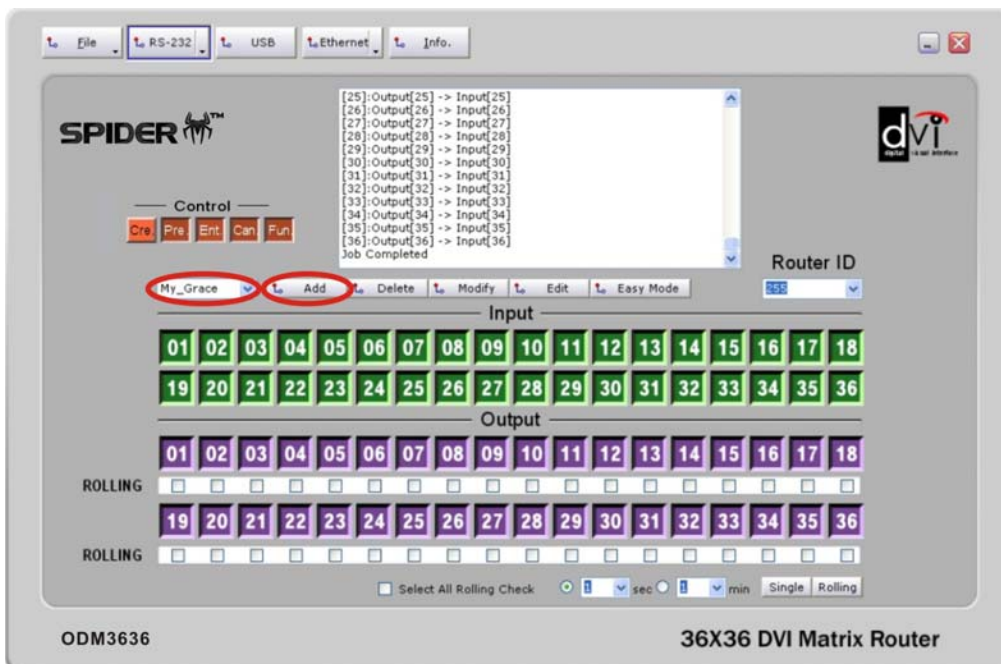

2) New switching-pattern is displayed.

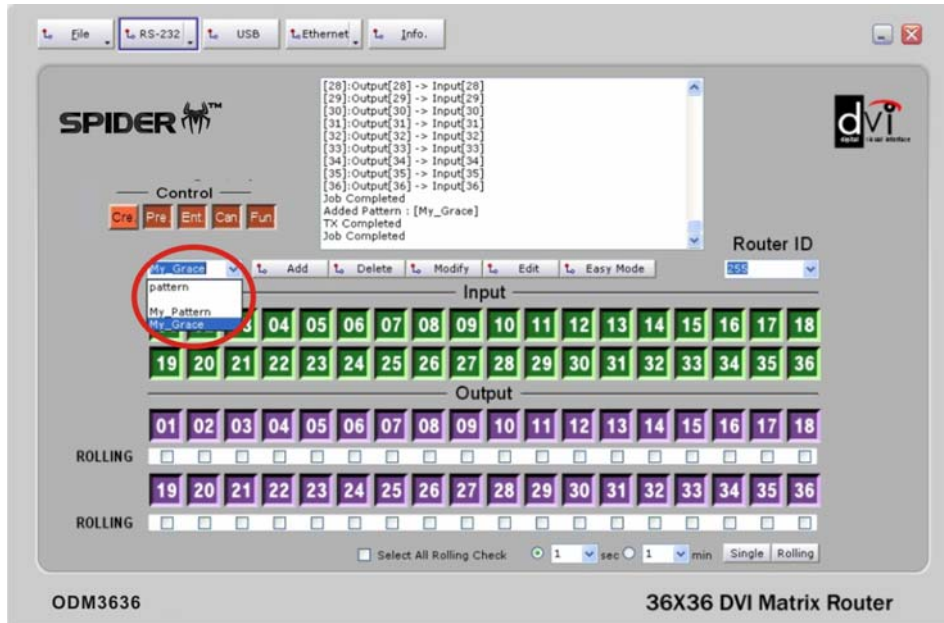

3) Select **Edit** to modify switching-pattern and Input-Output names.

- **Modify**
 - 1) Select the switching-pattern to be modified.
 - 2) Write down the new pattern name in the combo box.
 - 3) Select **Modify** (similar to "Save As" in windows).
- **Delete**
 - 1) Select the pattern name to be deleted.
 - 2) Select **Delete**
 - 3) Selected pattern name is deleted from the combo box list.

3.8 Rolling Function

- Allows users to rotate Input sources.
- Used to verify all Input-Output connections.
- Select Output channels to be rolled using the Check Box.
 - If Output channel was not connected to any Input channel, **Check Box** would not be checked.
 - Must have at least 2 Output Channels.

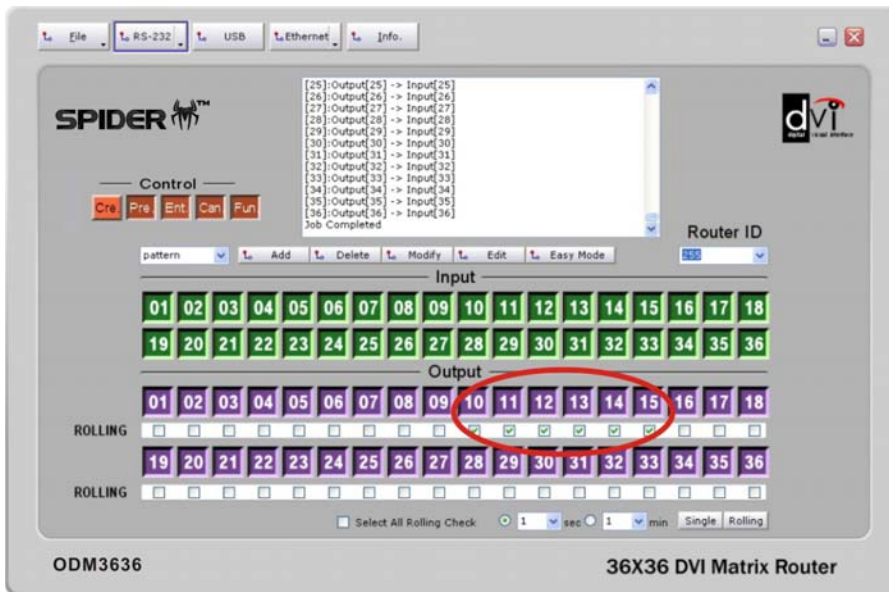

- For example:
 - The current switching-pattern depicted in step 1 below.
 - To rotate Input channels on Output 1, 2, 3, 4, and 5, check the rolling box 1, 2, 3, 4 and 5 then set the desired interval.

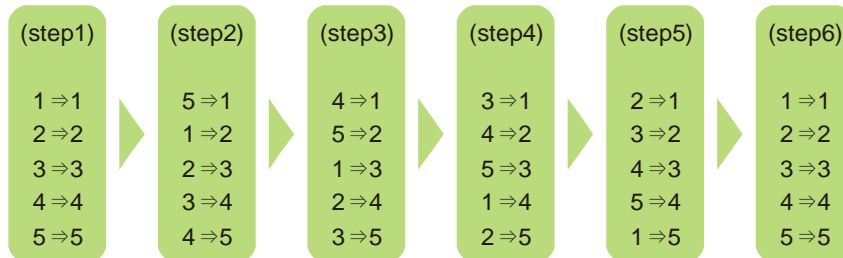

- The lowest channel Input LED and connected Output channel LED on Router will be turned on. (In this case Input 1 and Output 1 will be tuned on)

3.8.1 Single Rolling

- Select **Single**
- The Output will change continuously at specified interval from step 1 to step 6 then automatically stop. Pushing the Stop button can stop rolling.
- The Output image will remain in current state.

3.8.2 Unlimited Rolling

- Rotates the Input continuously on the Output displays until the user selects the **Stop**. Stopping the rolling does not affect the pre-saved switching-pattern.
- To exit rolling, select new pattern.

3.9 EDID Setting

3.9.1 Features:

- Store EDID
- Read EDID from Output device
- Read EDID from Output device and store it in Input EEPROM
- EDIT user defined EDID
- Restore default EDID (in all Input channels)
- One touch store (in all Input channels)
- Store EDID by individual selection
- Basic EDID structure: EDID Block 0 [128 bytes]

3.9.2 Importance of EDID - Example

- Four (4) sources with four (4) different types of displays configured as below: - Source Input 1 is distributed to Output 1 and 4.

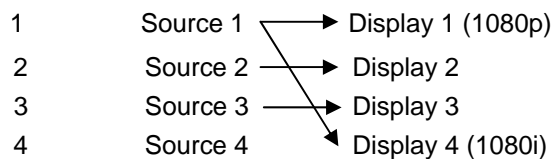

- Resolution of Display 1 is 1080p and Display 4 is 1080i
- Input 1 EDID must be set a 1080i for all Output 1 and 4 Displays to show 1080i image.
- If Input 1 EDID is set to 1080p, Display 4 cannot display the image

3.9.3 Setting EDID

- Select 'Files Button', and go to EDID setting.
- This section consist of two functions:
 - EDID EDIT & Write EDID Data from PC
 - Write EDID Data from Output Device

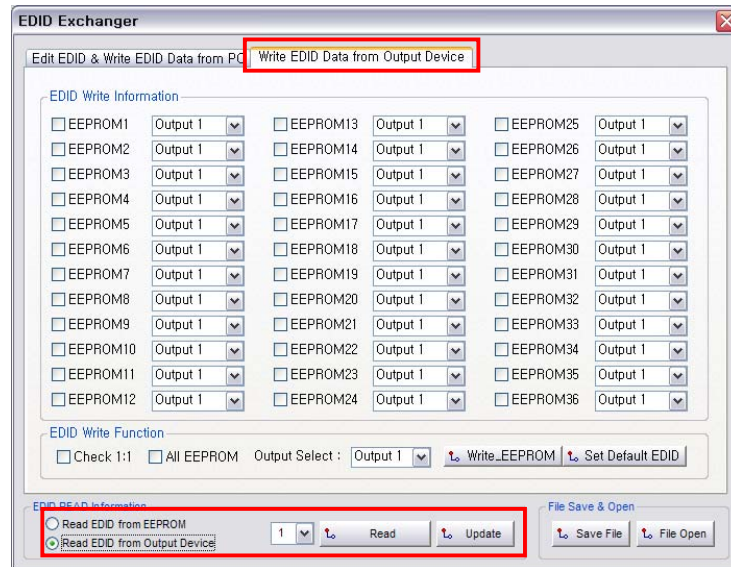

3.9.4 Write EDID

- 1) Select **Files**, and go to EDID setting.
- 2) Select **Write EDID Data from Output Device** tab on top.
- 3) Verify all EEPROM # and select OUTPUT#.
- 4) Select **WRITE_EEPROM** to save the EDID data.

[Note]

- **Check 1:1:** Same number will be assigned for EEPROM # and Output #
- **All EEPROM:** Select all EEPROM
- **Set Default EDID:** All EEPROM is reset to factory default values.

3.9.5 Read EDID

- 1) Select **Files** and go to EDID setting.
- 2) Select **Write EDID Data from Output Device** tab on top.
- 3) Select **Read EDID from EEPROM** in EDID Read information.
- 4) Select the number of EEPROM and select **Read**.
- 5) Select the **Update** to update the information to PC.

- EDID information will appear in the Edit EDID & Write EDID Data from Output Device, [1] General.

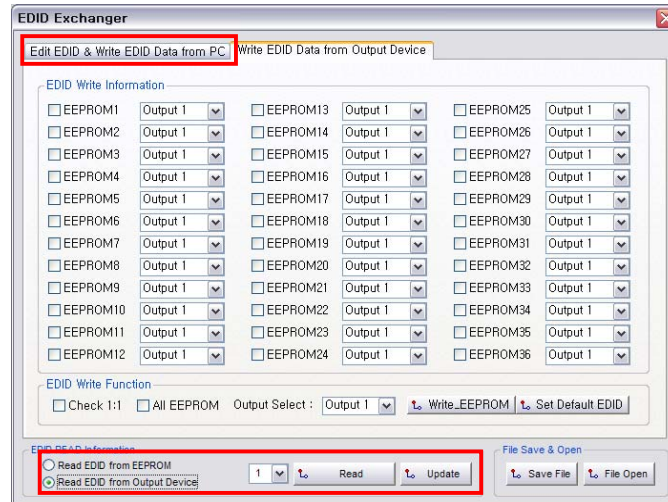

3.9.6 Read EDID from Output Device

- Select **Files** and go to EDID setting.
- Select **Write EDID Data from Output Device** tab on top.
- Select **Read EDID from Output Device** in EDID Read information.
- Select the number of Output Device and select **Read**.
- Select the **Update** button to update the information to PC.
- The EDID information will appear in the Edit EDID & Write EDID Data from Output Device, [1] General.

3.9.7 File Save/Open EDID

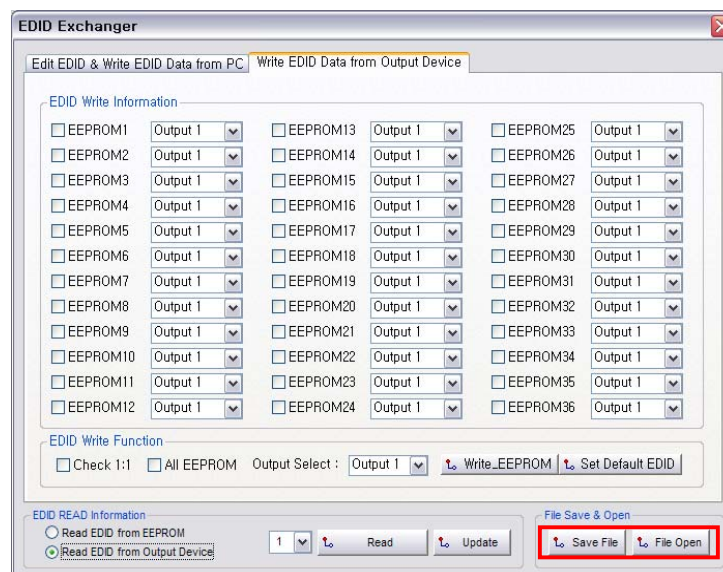

- File save
 - 1) Select **Files**, and go to EDID setting.
 - 2) **Read** or **Edit** EDID data.
 - 3) Select **Save File** to save changes to PC.
- File open
 - 1) Select **Files**, and go to EDID setting
 - 2) Select **File open** to recall saved EDID data.
 - 3) The EDID information will appear in the Edit EDID & Write EDID Data from Output Device, [1] General.

3.9.8 EDID EDIT

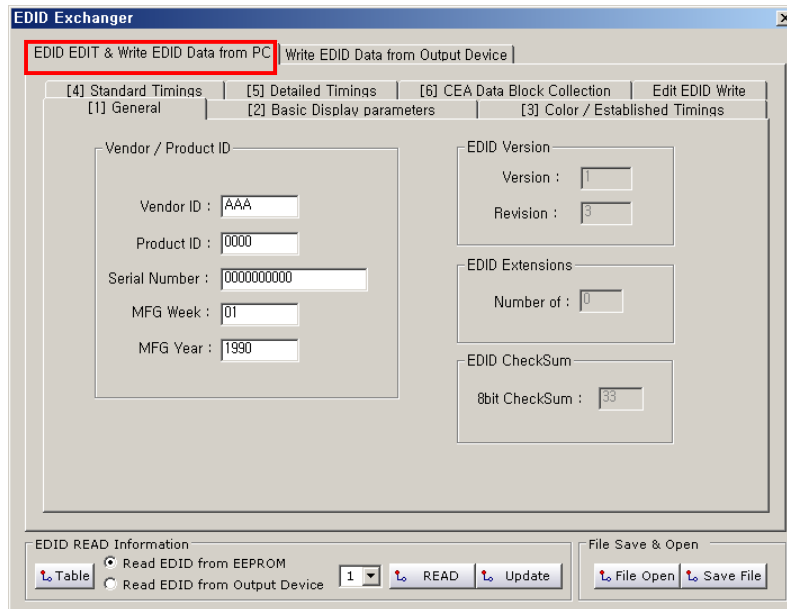

- 1) Select **Files**, and go to EDID setting.
- 2) Select **Edit EDID & Write EDID data** tab on top.
- 3) **Edit** EDID data by completing each tab sections from [1] to [5].
- 4) Go to **Write EDID Data from Output Device**
- 5) Select EEPROM# and select **WRITE_EEPROM**.
- 6) Data will be stored into EEPROM



4 Troubleshooting

Problem	Symptom	Remedy
Power	No Power LED	Check the power cord is correctly connected to the ODM3636 and to an AC power source and that the power switch is in the ON position
Output	No Output present	Check the Input Output DVI cables are firmly connected to each port of ODM3636 and double check the Input Output connection configuration you want.
		The display is not capable of handling graphic resolution. Check the compatibility of EDID in the EEPROM and attached displays. When a single Input is routed to multiple outputs, lower resolution EDID should be selected. EX> Input 1 → Output 1 (UXGA) & Output 2(SXGA) If EEPROM 1 store the display 1 EDID (UXGA), the display 2 (SXGA) will not work due to resolution limit.
		The source has stopped sending a graphic signal. Check that Input source status by connecting it to available monitor without the ODM3636.



5 Features

This unit is designated to make cross-switch between the 36 DVI inputs and the 36 DVI outputs in a way of any of 36 inputs to one or multiple outputs. Chassis is hardened enough to be applicable in harsh environments like staging, control room and military.

- 1) Enables to connect the maximum 36 independent displays.
- 2) Each Output port can be used as a Signal-Distributor.
- 3) Supports Windows PLUG & PLAY function.
- 4) Offers various control interfaces like Front-Key Input, RS-232, USB and Ethernet communication.
- 5) Fulfills real-time display of running status on 20x4 LCD and with illuminated LED type keys.
- 6) Be rack-mountable with solid 19 inch standard RACK TYPE CASE.
- 7) Supports real-time Hot Plug Detection and program each EDID to connected DVI sources as per user's specification. (EDID programming option)
- 8) Offers various options to set EDID to enhance compatibility.

6 Specification

- 1) Input & Output Video Signals Type: TMDS (Transient Minimized Differential Signal)
- 2) DVI Signal Bandwidth: Maximum 1.65Gbps
- 3) Resolution: VGA (640x480) ~ WUXGA (1920x1200), 480~1080i and 1080p
- 4) RS-232 baud rates: 19,200bps ~115,200bps
- 5) LAN Port: 10/100 bases
- 6) USB: Hi-speed USB 2.0
- 7) AC/DC Power Supply: 110~240V/1.5A, 50~60Hz, DC12V/10A
- 8) Power Consumption: Maximum inner power 24W (Maximum total 60W when connected 36's output optical cables)
- 9) Size 483 x 265 x 355mm (W x D x H)
- 10) Weight: 15.5Kg (Router only)

7 Firmware downloading

7.1 Installation of the Ponyprog2000

- *PonyProg 2000 is a firmware update software program for ODM3636
- Follow the instructions below to install the PonyProg2000 software into your PC.

Insert the software CD into your PC and execute setup.exe.
The following screen will open. Then, click NEXT button.

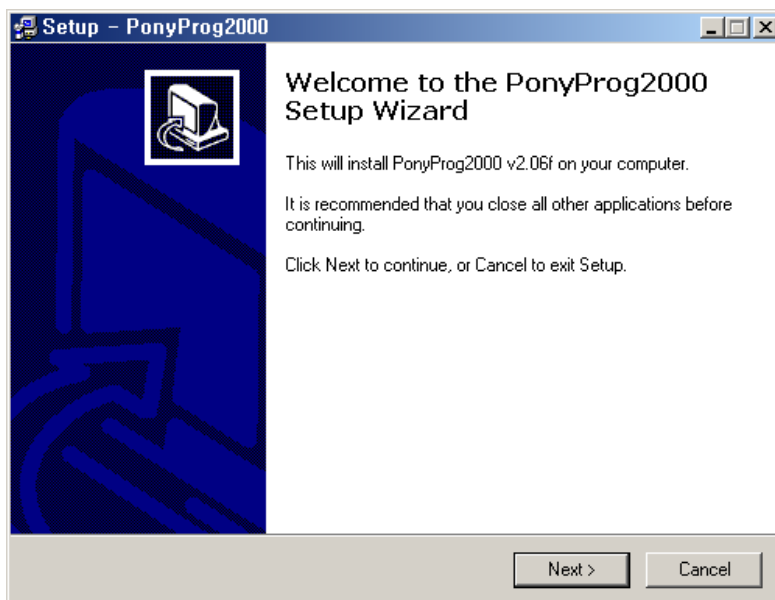

Check the 'I accept the agreement'

USER MANUAL

DVI MATRIX ROUTER – ODM3636

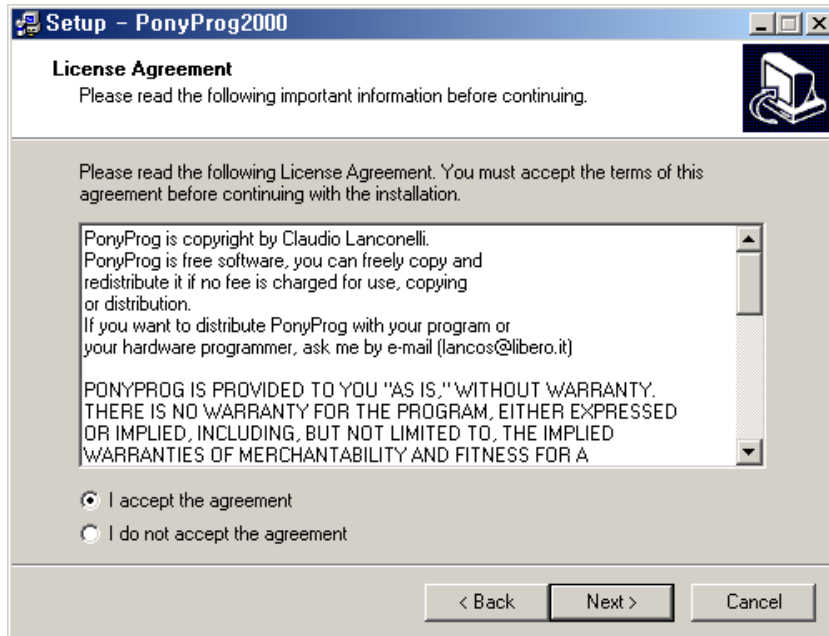

Define destination directory and click 'Next' button.

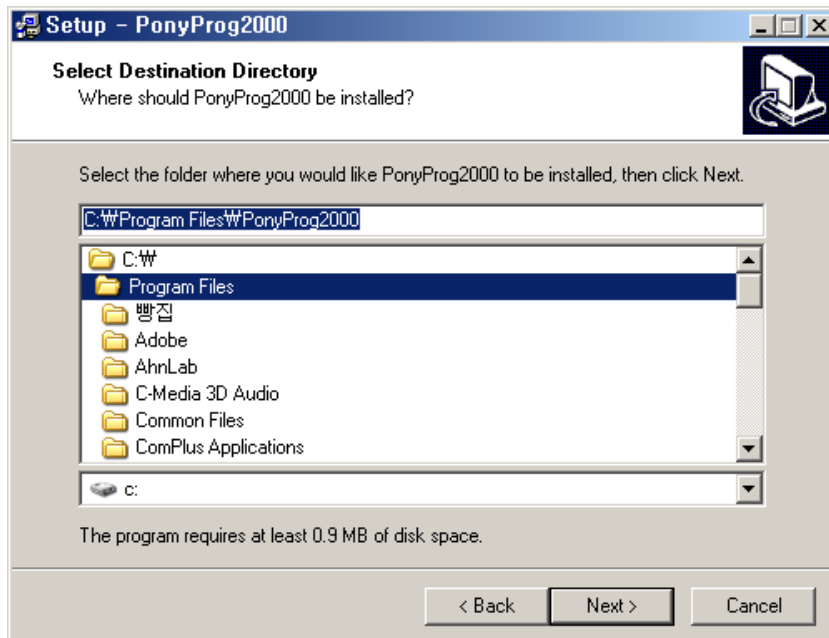

USER MANUAL

DVI MATRIX ROUTER – ODM3636



Select Start Menu Folder as below.

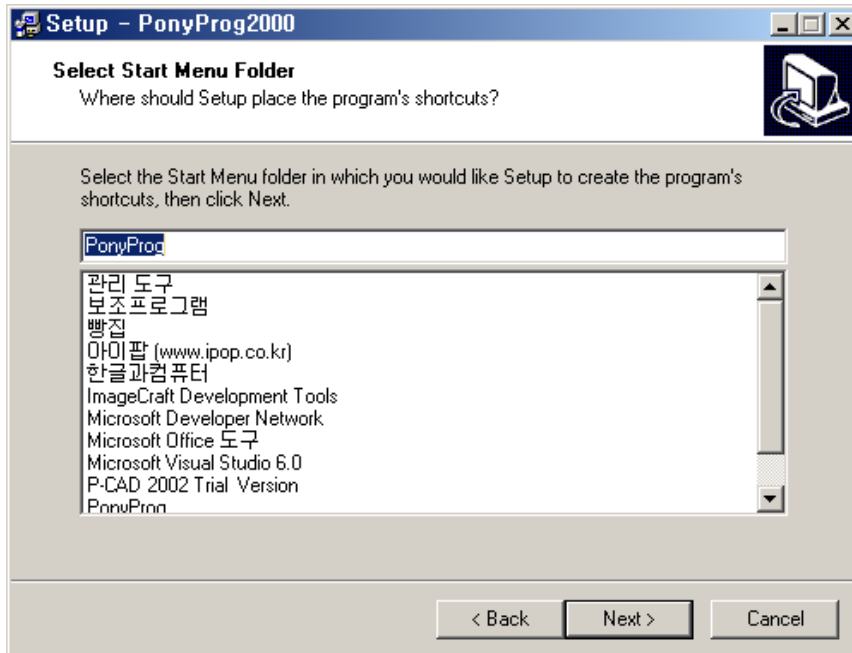

Select 'Install' button to install the software in your PC

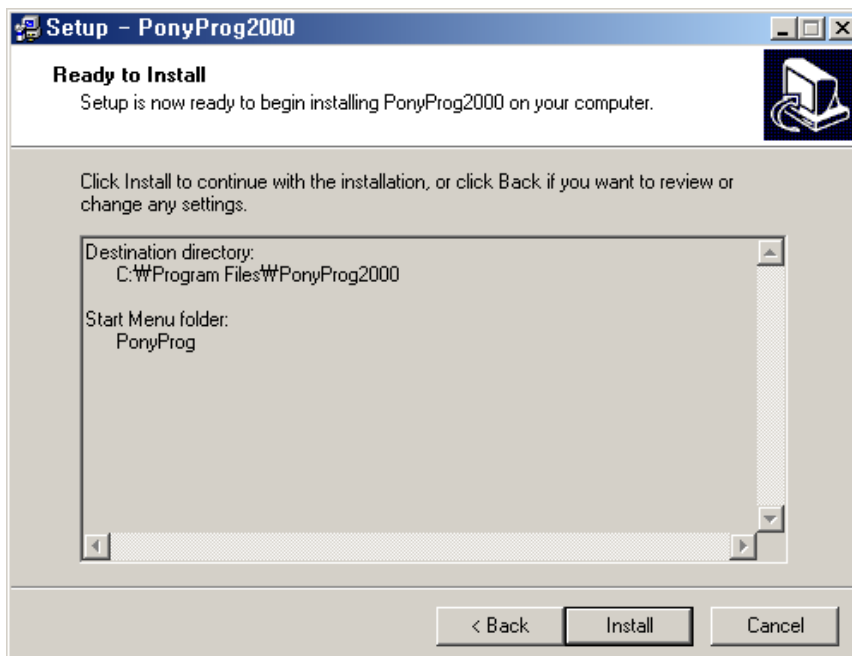

USER MANUAL

DVI MATRIX ROUTER – ODM3636



Select 'Finish' then PonyProg2000 will be installed in your PC successfully.

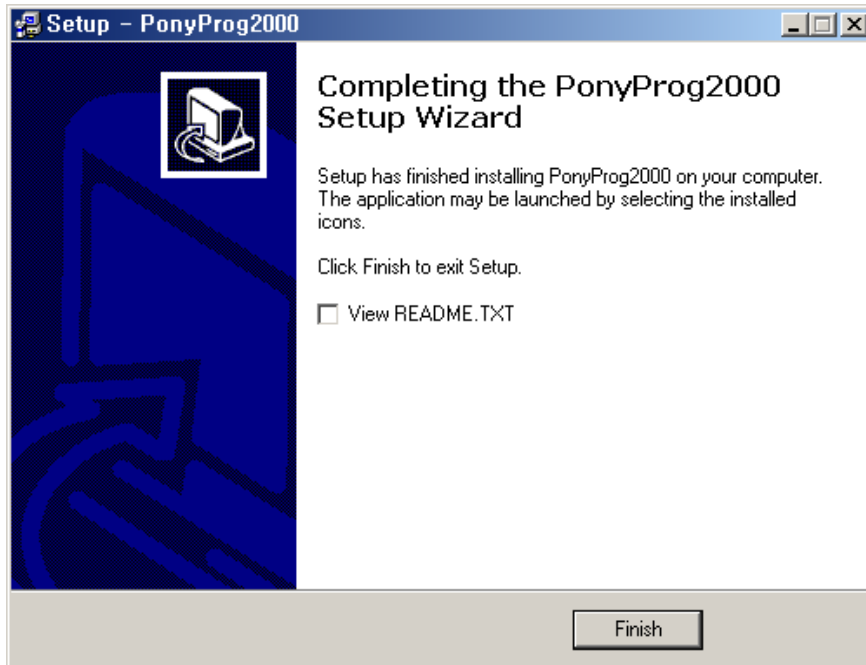

Select 'Install' button to install the software in your PC

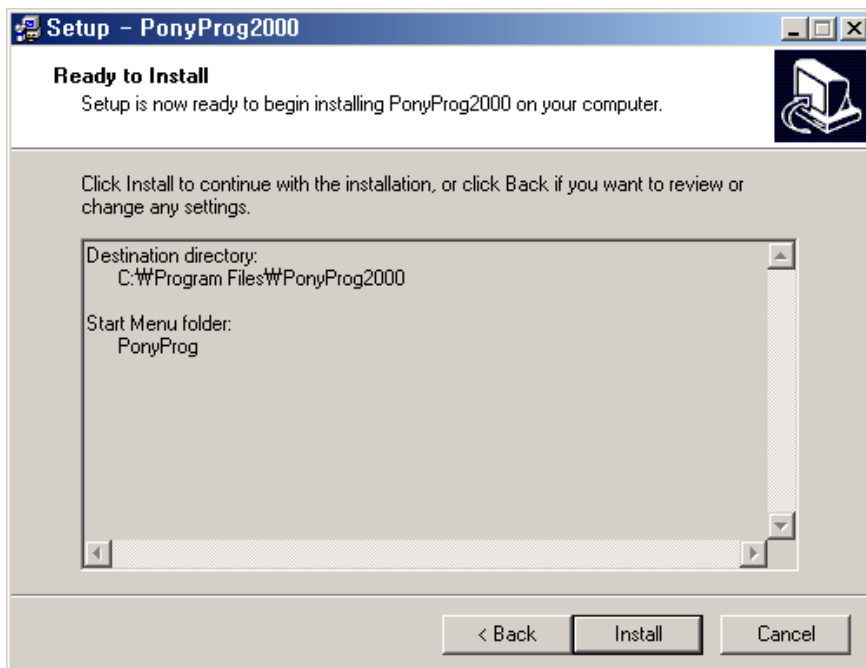

USER MANUAL

DVI MATRIX ROUTER – ODM3636



Select 'Finish' then PonyProg2000 will be installed in your PC successfully.

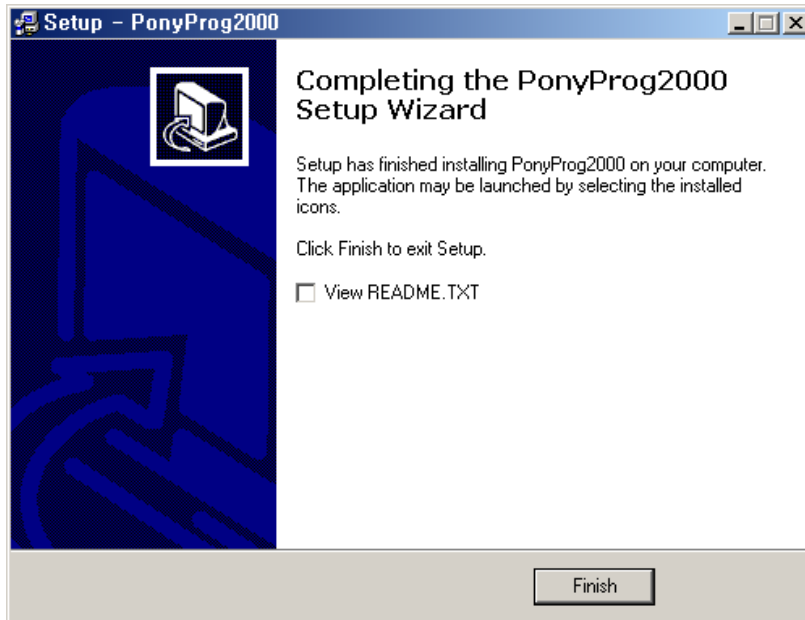

USER MANUAL

DVI MATRIX ROUTER – ODM3636



7.2 Download of Firmware

Turn on the Router and connect Router (to Download port) and PC (to Parallel port) over firmware download cable.

Execute PonyProg2000.exe and click 'OK'.

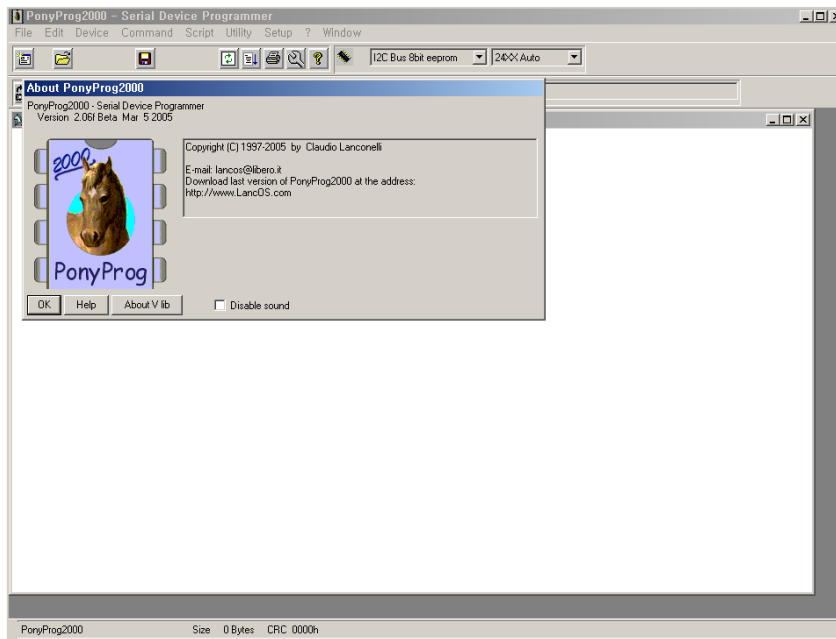

Select 'OK' button for calibration.

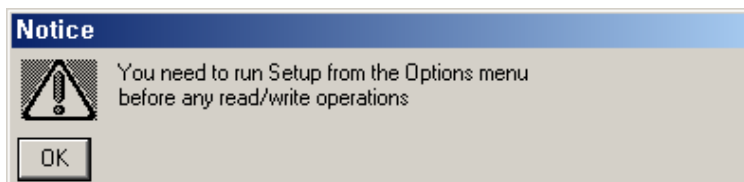
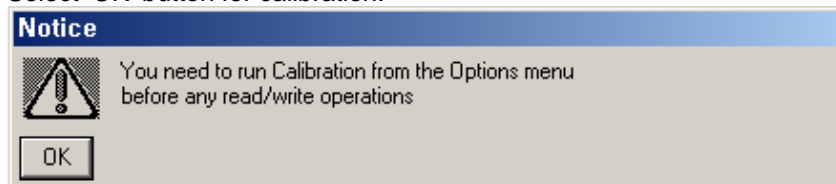

USER MANUAL

DVI MATRIX ROUTER – ODM3636



Select 'AVR micro' as below.

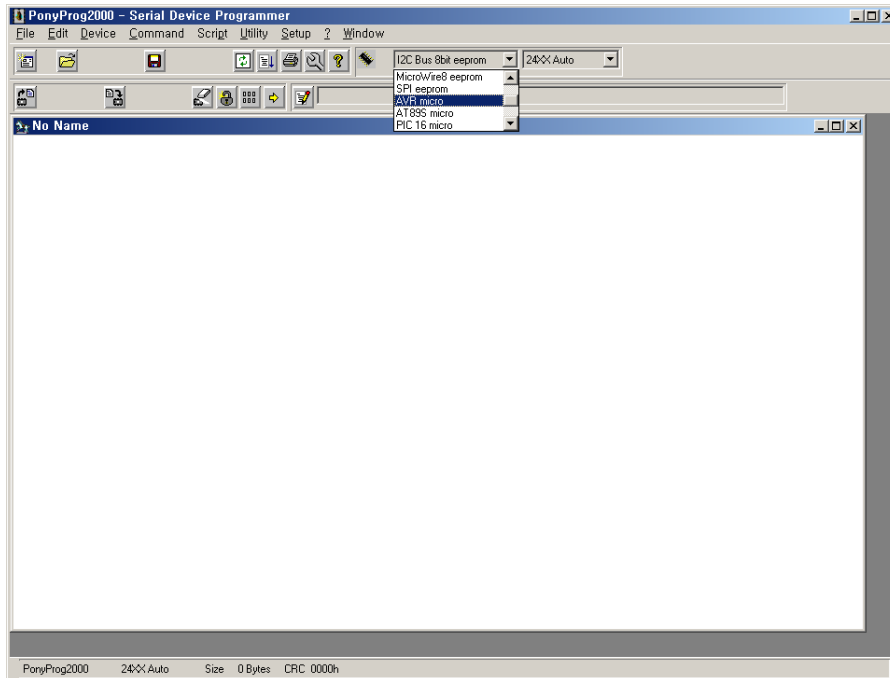

Select 'AT mega128' as below.

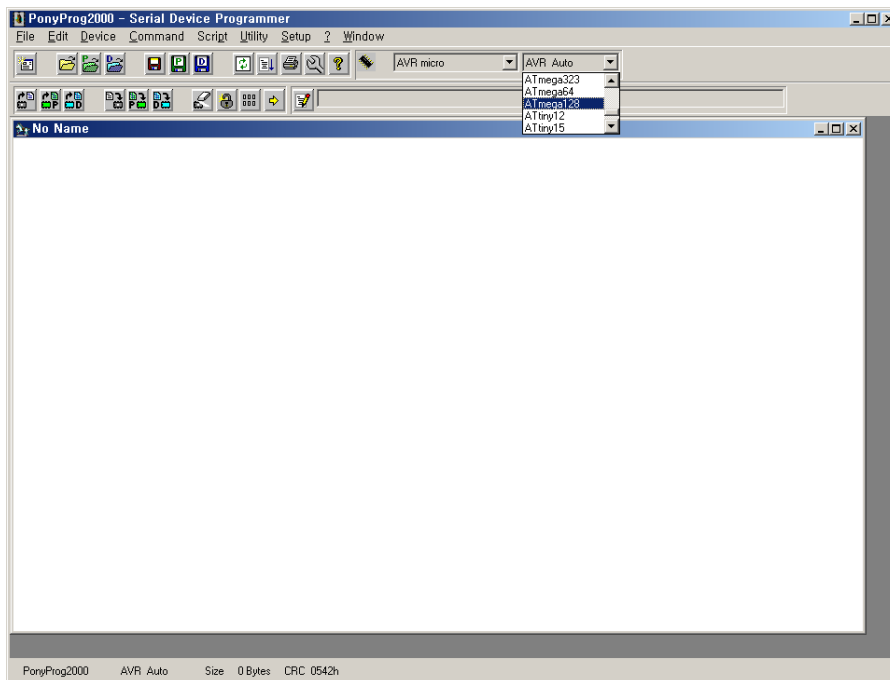

USER MANUAL

DVI MATRIX ROUTER – ODM3636



Select 'Interface Setup' in Setup menu as below.

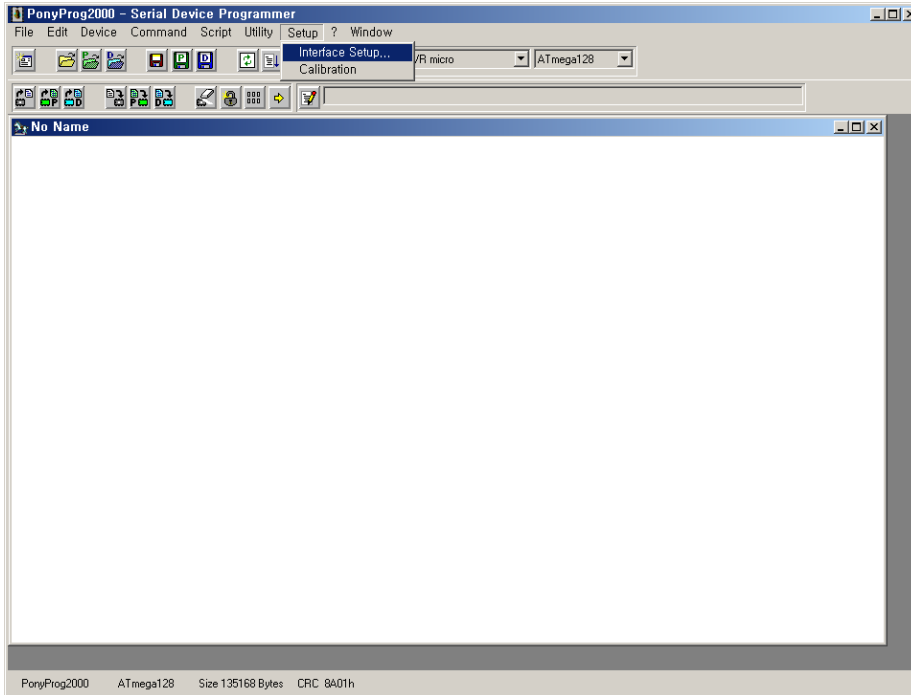

Set I/O port as below and click 'OK' button

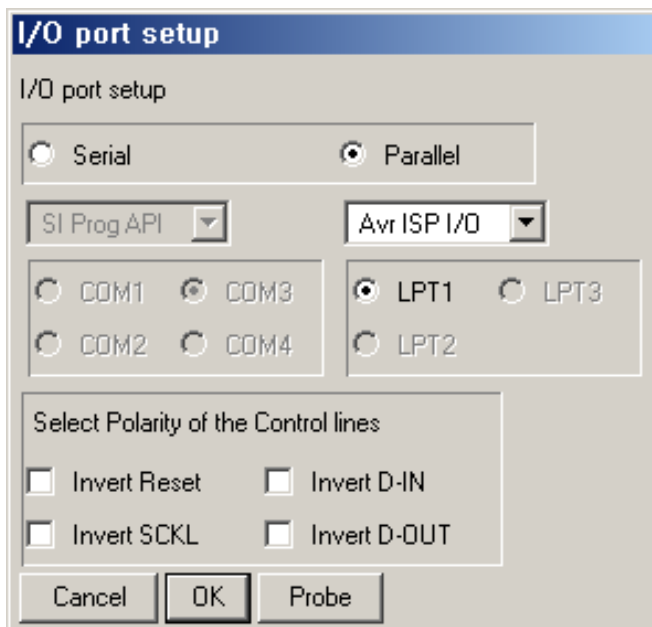

USER MANUAL

DVI MATRIX ROUTER – ODM3636



Select 'Security and Configuration Bits' in Command menu.

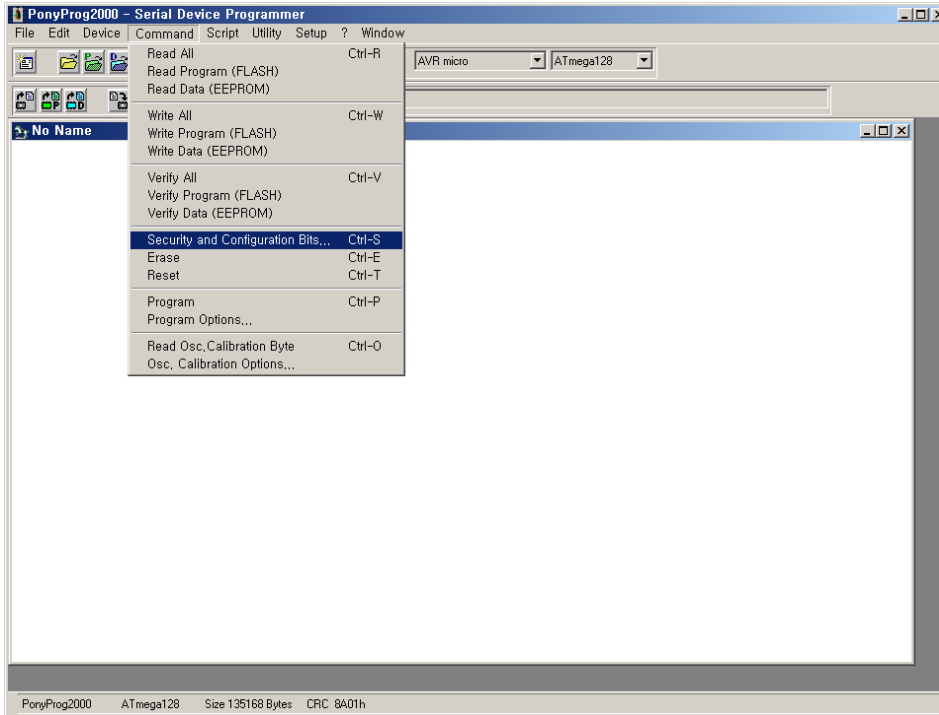

Select the 'Read' button and make sure the option is set as below.
 If the option is not same as below, click the 'Clear All' and mark it as below.
 Then click 'Write' button and click 'Read' button.
 If the option is same as below, click 'OK'.

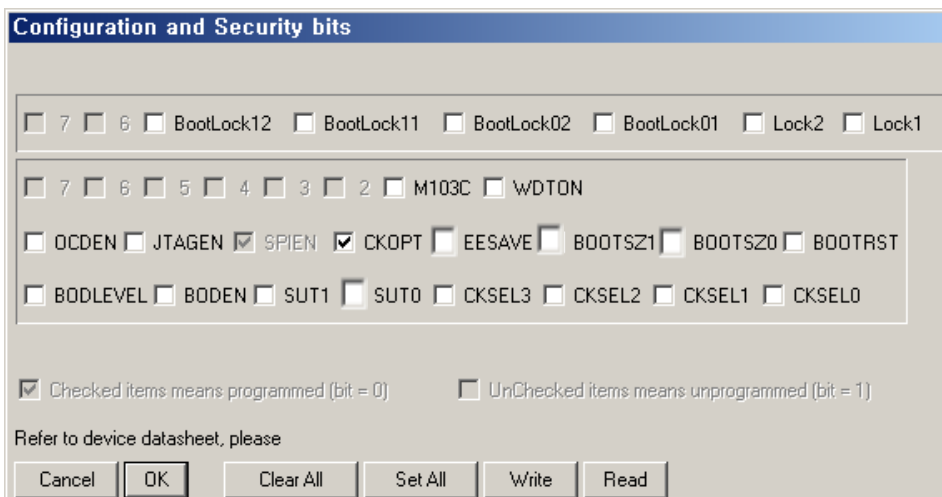

USER MANUAL

DVI MATRIX ROUTER – ODM3636



Select 'Open Program (FLASH) File' in File menu and select new firmware to download.

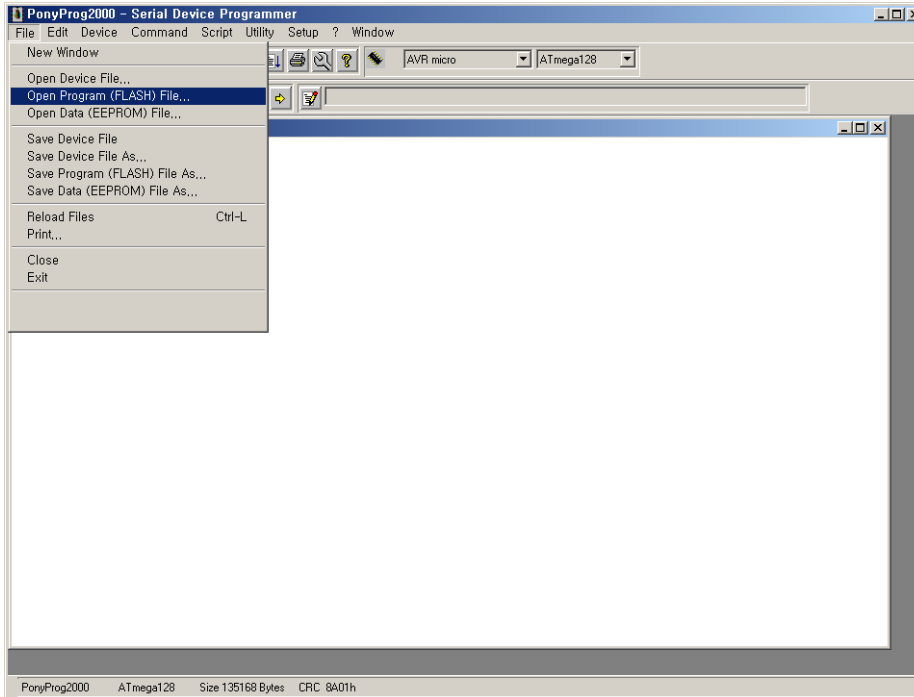

Select 'Write Program(FLASH)' in Command menu.

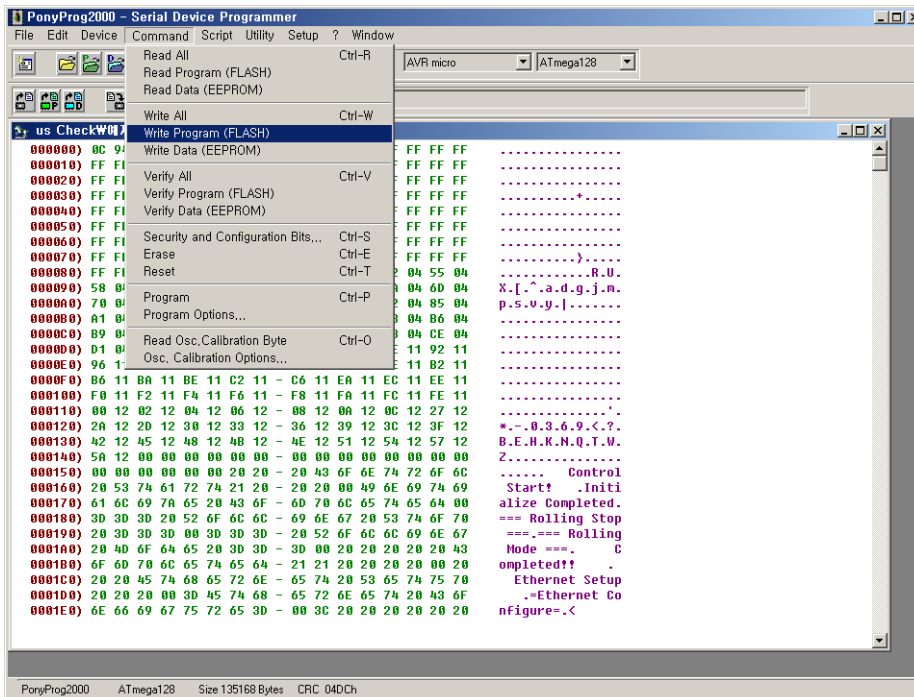

USER MANUAL

DVI MATRIX ROUTER – ODM3636



Select 'OK' button to starts downloading and verifying process in order.

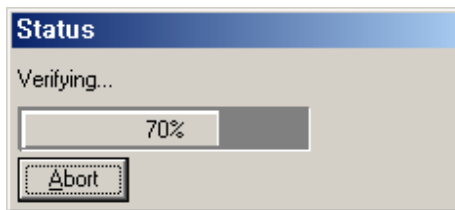
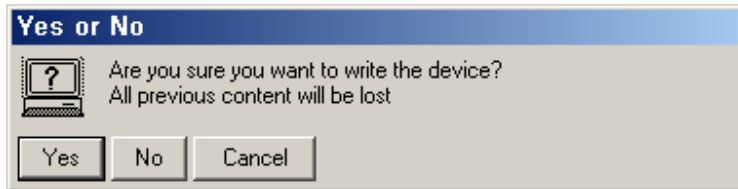

Select 'OK' to terminate the downloading.

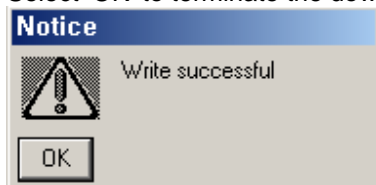

Now the Router is operated under the new firmware.

USER MANUAL

DVI MATRIX ROUTER – ODM3636



Opticis Locations

Opticis Co., Ltd.

#501 Byucksan Technopia, 434-6,
Sangdaewon-Dong,
Chungwon-Ku, Sungnam City,
Kyungki-Do, 462-120, South Korea
Tel: +82 (31) 737-8033
Fax: +82 (31) 737-8079

Opticis USA LLC

649 Route 206
Unit 9 Suite 307
Hillsborough, NJ 08844
USA
Tel: +1 (908) 837-9652
Fax: +1 (908) 837-9087

For order support, please contact your Distributor or Reseller.

For technical support, visit Opticis web site www.opticis.com or contact techsupport@opticis.com